

KEMA TEST REPORT

17013-K

Object	Voltage Stabilizing Device		
Type	Phaseback – VSGR (Voltage Stabilizing Ground Reference)	Serial No.	N/A
	480 V, rms – 3 phase – 60 Hz		
Client	Borg General Sales, LLC Elk Grove Village, IL, USA		
Tested by	KEMA Powertest LLC, 4379 County Line Road Chalfont, PA 18914 USA		
Date of tests	13 January 2017		
Test specification	The tests have been carried out in accordance with the client's instructions.		
Remarks	The test object was subjected to phase to ground overvoltage withstand.		

This report applies only to the object tested. The responsibility for conformity of any object having the same type references as that tested rests with the Manufacturer.

This report consists of 47 pages in total.

KEMA-Powertest, LLC.

Victor Savulyak
Head of Department, Operations

Chalfont, _____



INFORMATION SHEET

1 KEMA Type Test Certificate

A KEMA Type Test Certificate contains a record of a series of (type) tests carried out in accordance with a recognized standard. The equipment tested has fulfilled the requirements of this standard and the relevant ratings assigned by the manufacturer are endorsed by DNV GL. In addition, the test object's technical drawings have been verified and the condition of the test object after the tests is assessed and recorded. The Certificate contains the essential drawings and a description of the equipment tested. A KEMA Type Test Certificate signifies that the object meets all the requirements of the named subclauses of the standard. It can be identified by gold-embossed lettering on the cover and a gold seal on its front sheet.

The Certificate is applicable to the equipment tested only. DNV GL is responsible for the validity and the contents of the Certificate. The responsibility for conformity of any object having the same type references as the one tested rests with the manufacturer.

Detailed rules on types of certification are given in DNV GL's Certification procedure applicable to KEMA Laboratories.

2 KEMA Report of Performance

A KEMA Report of Performance is issued when an object has successfully completed and passed a subset (but not all) of test programs in accordance with a recognized standard. In addition, the test object's technical drawings have been verified and the condition of the test object after the tests is assessed and recorded. The report is applicable to the equipment tested only. A KEMA Report of Performance signifies that the object meets the requirements of the named subclauses of the standard. It can be identified by silver-embossed lettering on the cover and a silver seal on its front sheet.

The sentence on the front page of a KEMA Report of Performance will state that the tests have been carried out in accordance with The object has complied with the relevant requirements.

3 KEMA Test Report

A KEMA Test Report is issued in all other cases. Reasons for issuing a KEMA Test Report could be:

- Tests were performed according to the client's instructions.
- Tests were performed only partially according to the standard.
- No technical drawings were submitted for verification and/or no assessment of the condition of the test object after the tests was performed.
- The object failed one or more of the performed tests.

The KEMA Test Report can be identified by the grey-embossed lettering on the cover and grey seal on its front sheet.

In case the number of tests, the test procedure and the test parameters are based on a recognized standard and related to the ratings assigned by the manufacturer, the following sentence will appear on the front sheet. The tests have been carried out in accordance with the client's instructions. Test procedure and test parameters were based on If the object does not pass the tests, such behavior will be mentioned on the front sheet. Verification of the drawings (if submitted) and assessment of the condition after the tests is only done on client's request.

When the tests, test procedure and/or test parameters are not in accordance with a recognized standard, the front sheet will state the tests have been carried out in accordance with client's instructions.

4 Official and uncontrolled test documents

The official test documents of DNV GL are issued in bound form. Uncontrolled copies may be provided as loose sheets or as a digital file for convenience of reproduction by the client. The copyright has to be respected at all times.

5 Accreditation of KEMA Laboratories

The KEMA Laboratories of DNV GL are accredited in accordance with ISO/IEC 17025 by the respective national accreditation bodies. The KEMA Laboratories in the Netherlands are in the RvA register under nos. L020, L218, K006, K009 and I049. The KEMA Laboratory in the United States is accredited by the A2LA under no. 0553.01. The KEMA Laboratory in the Czech Republic is accredited by CAI under no. 1035.

TABLE OF CONTENTS

	PAGE
Cover sheet	1
Information sheet.....	2
Table of contents	3
Identification of object tested	4
General information.....	5
Tabulation of data-performance record.....	6-8
Circuit schematic (lab2407)	9
Test circuit & instrumentation data sheet.....	10
Instrument information sheet	11

Attachments:

Applied Energy Test Plan for Testing Phaseback Test Device [1 PAGE]

Photographs (26) [13 PAGES]

Data acquisition system plots (trials 1-12) [21 PAGES]

END OF DOCUMENT [1 PAGE]

Draft - Report
KEMA Laboratories

IDENTIFICATION OF THE OBJECT TESTED

Ratings/characteristics of the object tested

Operating voltage	480 V, rms
Number of phases	3
Power frequency	60 Hz

Description of the object tested

Voltage stabilizing device, Phaseback – VSGR (Voltage Stabilizing Ground Reference)

Draft - Report
KEMA Laboratories

GENERAL INFORMATION

The tests were witnessed by

Name	Company
William Stewart	Applied Energy LLC Saginaw, MI, USA

The tests were carried out by

Name	Company
Kresimir Starcevic	KEMA Powertest LLC, Chalfont PA USA

Accuracy of measurement

The guaranteed uncertainty in the figures mentioned, taking into account the total measuring system, is less than 3%, unless mentioned otherwise. Measurement uncertainty can be verified by reviewing the instrument calibration records. The instruments used are calibrated on a regular basis and are traceable to the National Institute of Standards and Technology.

Test Summary

The client submitted one voltage stabilizing device, Phaseback – VSGR, in good condition, to be subjected to phase to ground overvoltage withstand tests in accordance with the client's instructions.

The client requested phase to ground overvoltage withstand tests on the voltage stabilizing device, Phaseback – VSGR in accordance with the client's instructions. These test requirements are summarized in the test plan attached to this report.

The phase to ground overvoltage withstand tests for the voltage stabilizing device, Phaseback – VSGR were performed in accordance with the client's instructions.

TABULATION OF DATA-PERFORMANCE RECORD

TEST DEVICE: Borg General Sales - Phaseback VSRG **TEST NO.:** 17013-K
TYPE OF TEST: Phase to ground overvoltage withstand **DATE:** January 12, 2017
TEST OBSERVERS: DNV GL KEMA lab personnel. William Stewart (Applied Energy) for 1/13/2017 **TESTER:** KS, BS

Trial	Sample	Test Duty	O.C.V. (V)	Phase	Total (A)	Sym (A)	Peak (A)	Total @ End (A)	Sym @ End (A)	TD Gnd I pk (A)	Curr. Dura. (ms)	Transient Duration (µs)	Phase	C.C. Volts (V)	Transient Peak (V)	Remarks	
1		Cap	-	A	-	-	-	-	-	-	-	-	A-N	-	-	1,4	
	2.5kV	Disch.		B	-	-	-	-	-	-	-	-	B-N	-	-		
	Charge			C	-	-	-	-	-	-	-	134	C-N	-	1221		
				AVG	-	-	-	-	-	-	-	-	AVG L-L	-	-		
2		Cap	-	A	-	-	-	-	-	-	-	-	A-N	-	-	1	
	5kV	Disch.		B	-	-	-	-	-	-	-	-	B-N	-	-		
	Charge			C	-	-	-	-	-	-	-	141	C-N	-	2727		
				AVG	-	-	-	-	-	-	-	-	AVG L-L	-	-		
3		Cap	-	A	-	-	-	-	-	-	-	Long	A-N	-	2953	2	
	2.5kV	Disch.		B	-	-	-	-	-	-	-	Long	B-N	-	3020		
	Charge			C	-	-	-	-	-	-	-	Long	C-N	-	2654		
				AVG	-	-	-	-	-	-	-	-	AVG L-L	-	-		
4		Cap	-	A	-	-	-	-	-	-	-	Long	A-N	-	5093	2	
	5kV	Disch.		B	-	-	-	-	-	-	-	Long	B-N	-	5059		
	Charge			C	-	-	-	-	-	-	-	Long	C-N	-	4907		
				AVG	-	-	-	-	-	-	-	-	AVG L-L	-	-		
5		Ckt	480	A	30.2	25.49	52.59	-	25.48	-	390	282	A-N	286	-	3	
	2.4kV	Cal		B	32.47	25.51	55.86	-	25.48	-	390	828	B-N	272	-		1/13/2017
	Charge			C	43.64	25.5	71.78	-	25.19	-	390	828	C-N	280	400		
				AVG	35.44	25.5	-	-	25.38	-	-	-	-	AVG L-L	483.8		-

Remarks: 1) Generator aux breaker open. Load bank neutral grounded. 2) Generator aux breaker open. Load bank neutral ungrounded. 3) Ground on power source thru wye transformer. 4) For all test trials, energy from charged capacitor was injected in C phase.

TABULATION OF DATA-PERFORMANCE RECORD

TEST DEVICE: Borg General Sales - Phaseback VSRG **TEST NO.:** 17013-K
TYPE OF TEST: Phase to ground overvoltage withstand **DATE:** January 13, 2017
TEST OBSERVERS: DNV GL KEMA lab personnel. William Stewart (Applied Energy) for 1/13/2017 **TESTER:** KS, BS

Trial	Sample	Test Duty	O.C.V. (V)	Phase	Total (A)	Sym (A)	Peak (A)	Total @ End (A)	Sym @ End (A)	TD Gnd I pk (A)	Curr. Dura. (ms)	Transient Duration (µs)	Phase	C.C. Volts (V)	Transient Peak (V)	Remarks
6	6.0kV Charge	Ckt Cal	480	A	29.95	25.58	52.05	-	25.55	-	389	1130	A-N	277	-	1,4
				B	32.16	25.43	55.37	-	25.48	-	389	1130	B-N	275	-	
				C	42.83	25.45	70.90	-	25.25	-	389	1130	C-N	289	772	
				AVG	34.98	25.49	-	-	25.42	-	-	-	AVG L-L	486	-	
7	2.4kV Charge	Ckt Cal	480	A	30.46	25.68	53.08	-	25.71	-	390	18.6ms	A-N	278	1340	2
				B	32.06	25.57	55.18	-	25.62	-	390	16.4ms	B-N	282	1043	
				C	43.91	25.69	72.17	-	25.57	-	390	29.9ms	C-N	285	1398	
				AVG	35.48	25.65	-	-	25.63	-	-	-	AVG L-L	488	-	
8	6.0kV Charge	Ckt Cal	480	A	30.54	25.72	53.22	-	25.76	-	390	20.0ms	A-N	277	2729	2
				B	32.24	25.63	55.63	-	25.57	-	390	21.2ms	B-N	284	2544	
				C	43.54	25.62	25.62	-	25.48	-	390	30.1ms	C-N	283	3213	
				AVG	35.44	25.66	-	-	25.60	-	-	-	AVG L-L	487	-	
9	2.4kV charge TD connected	With	480.00	A	35.61	28.44	62.79	-	25.67	-	390	339	A-N	279	-	2,3
				B	33.17	26.34	57.03	-	25.30	-	390	339	B-N	278	-	
				C	50.27	28.66	82.76	-	25.51	-	390	339	C-N	280	461	
				AVG	39.68	27.81	-	-	25.50	-2.03	-	-	AVG L-L	483	-	
10	6.0kV charge TD connected	With	480.00	A	34.40	27.84	60.40	-	25.60	-	390	296	A-N	280	-	2,3
				B	34.09	26.67	58.59	-	25.51	-	390	296	B-N	275	-	
				C	48.53	28.08	80.08	-	25.53	-5.33	390	296	C-N	281	727	
				AVG	39.01	27.53	-	-	25.55	-	-	-	AVG L-L	483	-	

Remarks: 1) Ground on power source thru wye transformer. 2) Ungrounded system. 3) Test device distorts voltage for duration of ~200ms during switching on of load current. 4) For all test trials, energy from charged capacitor was injected in C phase.

TABULATION OF DATA-PERFORMANCE RECORD

TEST DEVICE: Borg General Sales - Phaseback VSRG **TEST NO.:** 17013-K
TYPE OF TEST: Phase to ground overvoltage withstand **DATE:** January 13, 2017
TEST OBSERVERS: DNV GL KEMA lab personnel. William Stewart (Applied Energy) for 1/13/2017 **TESTER:** KS, BS

Trial	Sample	Test Duty	O.C.V. (V)	Phase	Total (A)	Sym (A)	Peak (A)	Total @ End (A)	Sym @ End (A)	TD Gnd I pk (A)	Curr. Dura. (ms)	Transient Duration (µs)	Phase	C.C. Volts (V)	Transient Peak (V)	Remarks
11	2.4kV charge	With	480.00	A	33.59	27.62	58.84	-	25.76	-	390	263	A-N	286	-	1,2,3,4
	TD connected			B	33.25	26.16	57.18	-	25.51	-	390	263	B-N	275	-	
				C	55.99	31.18	91.94	-	25.67	-	390	263	C-N	277	475	
				AVG	40.94	28.32	-	-	25.65	8.2 clip.	-	-	AVG L-L	484	-	
12	6.0kV charge	With	480.00	A	33.69	27.69	58.94	-	25.74	-	390	358	A-N	274	-	2,4
	TD connected			B	34.10	26.68	58.64	-	25.62	-	390	358	B-N	279	-	
				C	54.45	30.47	89.36	-	25.62	-	390	358	C-N	287	697	
				AVG	40.75	28.28	-	-	25.66	15.76	-	-	AVG L-L	485	-	

Remarks: 1) For all test trials, energy from charged capacitor was injected in C phase. 2) Ground on power source thru wye transformer. 3) Ground current clipped at 8.2A peak. Will increase the channel range for next test. 4) Peak ground current is result of switching of load current in grounded system and not of discharge of the charged capacitor.

Draft
 KEMA

CIRCUIT SCHEMATIC LAB2407

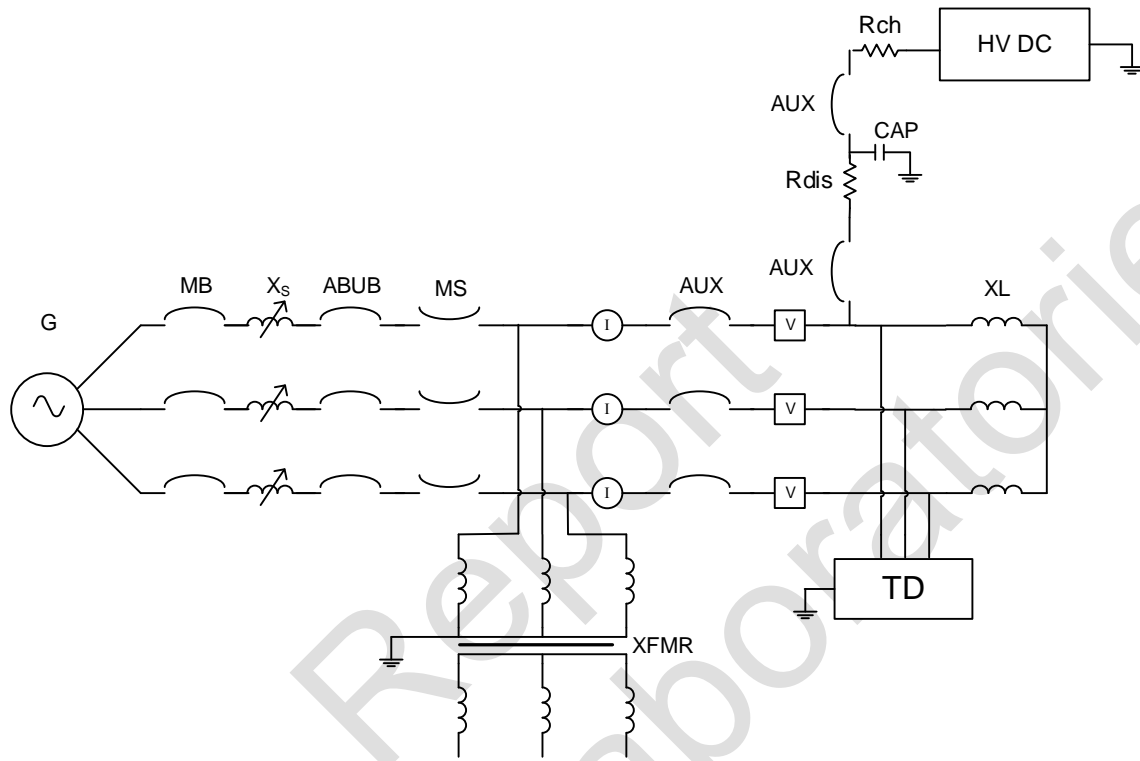

LEGEND

G	Generator
MB	Master Breaker
X _s	Station Reactance
ABUB	Auxiliary Back Up Breaker
MS	Making Switch
XFRM	Transformer
AUX	Auxiliary Circuit Breakers
R _{dis}	Discharge Resistor
R _{ch}	Charge Resistor
TD	Test Device
CAP	High Voltage Capacitor
HV PS	High Voltage DC Power Supply
I	Current Measurement
V	Voltage Measurement
X _L	Load Reactance

TEST CIRCUIT AND INSTRUMENTATION DATA SHEET

TEST DEVICE: Borg General Sales - Phaseback VSRG

TYPE OF TEST: Phase to ground overvoltage withstand

TEST NO.: 17013-K

GENERATOR CONNECTIONS

CIRCUIT DESCRP. FREQ. 60Hz PHASE: 3 DC: CELL NO: 3/4

TESTER: KS, BS

GENERATOR CONNECTED: G2 SY: PY: SD: X PD: RG: SG: NG: X

MISC. INSTRUMENTATION: PAV37, MSC131, MUL119

GROUND CONNECTIONS: Core and frame of test transformer - Shorting bar

SHEET: 1 of 1

CHAN. NO.	ISOBE NO.	ITEM MONITORED	INPUT DEVICE	INPUT RATIO OR RES.	DATA PANEL	DATA RATIO OR RES.	REMARKS	INSTRUMENTATION CHANGE								REMARKS
								CHANGE NO.	TRIAL NO.	CHAN. NO.	ISOBE NO.	ITEM MONITORED	INPUT DEVICE	INPUT RATIO OR RES.	DATA PANEL	
	ISO	DAS08														
1	74	A phase current	CTX199	50/5	CTS29	0.5Ω										
2	50	A-N voltage	VDR78	2000/1	ISO50		ch 13									
3	25	B phase current	CTX200	50/5	CTS29	0.5Ω										
4	45	B-N voltage	VDR80	2000/1	ISO45		ch 14									
5	68	C phase current	CTX201	50/5	CTS29	0.5Ω										
6	51	C-N voltage	VDR82	2000/1	ISO51		ch 15									
7	29	TD ground current	CTX146	10/5	CTS28	0.5Ω										
8	140	A-N G2 voltage	PTX06	120/1	VDR67	20/1										
9	23	B-N G2 voltage	PTX07	120/1	VTD67	20/1										
10	32	C-N G2 voltage	PTX08	120/1	VTD67	20/1										
11																
12																

TRIAL NO.	INST. CHNG. NO.	DATE	TIME	VOLTS RMS			HiPot Charge	CIRCUIT COILS / CODE NO.	Load bank Wye		Tran Cap (uF)	Xfrmr Neutral	Load Bank Neutral	TIMING RELAY CHANNEL, FUNCTION, AND SETTING IN SECONDS / LOOPS													
				IMPULSE VOLTS (V)	GEN. VOLTS (V)	O.C. TEST VOLTAGE (V)			1	3				4	5	2	8	10	11	12	14	23	24	E-Timer			
																									* TEST 2:	** TEST 3:	*** TEST 4:
1 - 4 Cap Cal		1/12/2017	1:30 PM	-	-	-	-							44	20	20	20	-	60	15 → 66	74	69	64	4	40	1	
5 - Cal		1/13/2017	9:27 AM	-	480	480	2,400	1,2,5,7 2083	11.1	-	1.3			44	20	20	20	15	60	15 → 66	74	69	64	4	39	5	
6 - Cal			9:30 AM	-	480	480	6,000	1,2,5,7 2083	11.1	-	1.3			44	20	20	20	15	60	15 → 66	74	69	64	4	39	6	
7 - Cal			9:38 AM	-	480	480	2,400	1,2,5,7 2083	11.1	-	1.3			44	20	20	20	15	60	15 → 66	74	69	64	4	39	6	
8 - Cal			9:40 AM	-	480	480	6,000	1,2,5,7 2083	11.1	-	1.3			48	20	20	20	15	60	15 → 66	74	69	64	4	39	8	
9 - With			10:01 AM	-	480	480	2,400	1,2,5,7 2083	11.1	-	1.3	No Grnd	No Grnd	48	20	20	20	15	60	15 → 66	74	69	64	4	39	8	
10 - With			10:08 AM	-	480	480	6,000	1,2,5,7 2083	11.1	-	1.3	No Grnd	No Grnd	48	20	20	20	15	60	15 → 66	74	69	64	4	39	8	
11 - With			10:47 AM	-	480	480	2,400	1,2,5,7 2083	11.1	-	1.3	Grounded	No Grnd	48	20	20	20	15	60	15 → 66	74	69	64	4	39	8	
12 - With			10:54 AM	-	480	480	6,000	1,2,5,7 2083	11.1	-	1.3	Grounded	No Grnd	48	20	20	20	15	60	15 → 66	74	69	64	4	39	8	

KEMA-Powertest, Inc.

Instrumentation Information Sheet

TEST NO: 17013-K

DATE: 01/13/2017

TEST DEVICE: Borg General Sales - Phaseback VSRG

TESTED BY: K. Starcevic, B. Swartz

CODE#	TYPE	MANUFACTURER	MODEL#	SERIAL#	CALIBRATION	
					LAST	DUE
PAV37	PNL.VOLTMTR	SIMPSON	F45-1-34	N/A	9/30/2016	4/18/2017
MSC131	AC/DC HIPOT	VITREK	944I	17222	4/4/2016	4/19/2017
MUL119	DMM	METERMAN	37XR	120405887	10/13/2016	5/1/2017
DAS08	DAS	NATION. INST	PC	C3EA6D	8/30/2016	3/18/2017
ISO74	ISOBE	NICOLET	ISOBE3000	IAV9301451	8/30/2016	3/18/2017
ISO50	ISO AMP	KEMA	TNK-9826-1	01	8/15/2016	3/3/2017
ISO25	FO ISO AMP	NICOLET	ISOBE 3000	IAV9802335	8/30/2016	3/18/2017
ISO45	ISO AMP	KEMA	TNK-9826-1	01	8/15/2016	3/3/2017
ISO68	FO ISO AMP	NICOLET	ISOBE 3000	IAV9100644	8/30/2016	3/18/2017
ISO51	ISO AMP	KEMA	TNK-9826-1	01	8/15/2016	3/3/2017
ISO29	FO ISO AMP	NICOLET	ISOBE 3000	IAV9802333	8/30/2016	3/18/2017
ISO140	FO ISO AMP	NICOLET	ISOBE 3000	IAV9200903	8/30/2016	3/18/2017
ISO23	FO ISO AMP	NICOLET	ISOBE 3000	IAV9802339	8/30/2016	3/18/2017
ISO32	FO ISO AMP	NICOLET	ISOBE 3000	IAV9802298	8/30/2016	3/18/2017
CTX199	C.T.	ABB	KIR11	41416111	9/1/2016	9/1/2018
CTX200	C.T.	ABB	KIR11	4146112	9/1/2016	9/1/2018
CTX201	C.T.	ABB	KIR11	41416113	9/1/2016	9/1/2018
CTS29	CT RES.BOX	KEMA-POWERT.	3CH@.5 OHM	29	12/21/2016	7/9/2017
CTX146	JKW-7	ITE	757X050018	7373161	2/2/2016	2/2/2018
CTS28	CT RES.BOX	KEMA-POWERT	3CH@.5 OHM	28	12/21/2016	7/9/2017
PTX06	P.T.	GE	JVM5	3737435	10/3/2016	10/3/2018
PTX07	P.T.	GE	JVM5	3737433	10/3/2016	10/3/2018
PTX08	P.T.	GE	JVM5	3737432	10/3/2016	10/3/2018
VDR67	DIVIDER	KEMA	20/1	67	11/8/2016	5/27/2017

Applied Energy Test Plan for Testing Phaseback Test Device (1.6.2016)

Available Source: 480V, 2.5kA, 3 ϕ , 60 hertz

Peak Voltage Supply: 2.4kV – 6kV

Load: 5-50 amps

Setup test circuit as outlined in the circuit schematic lab2407.

Perform a baseline test with the above source subjected to overvoltage from peak voltage supply.

Connect test device using #10 wire.

Test 1 – 480V, 2.5kA, 3 ϕ , 60 hertz, with 5-50 amp load, ~2.4kV (peak voltage supply) with grounded load.

Test 2 – 480V, 2.5kA, 3 ϕ , 60 hertz, with 5-50 amp load, ~6kV (peak voltage supply) with grounded load.

Test 3 – 480V, 2.5kA, 3 ϕ , 60 hertz, with 5-50 amp load, ~2.4kV (peak voltage supply) ungrounded.

Test 4 – 480V, 2.5kA, 3 ϕ , 60 hertz, with 5-50 amp load, ~6kV (peak voltage supply) ungrounded.



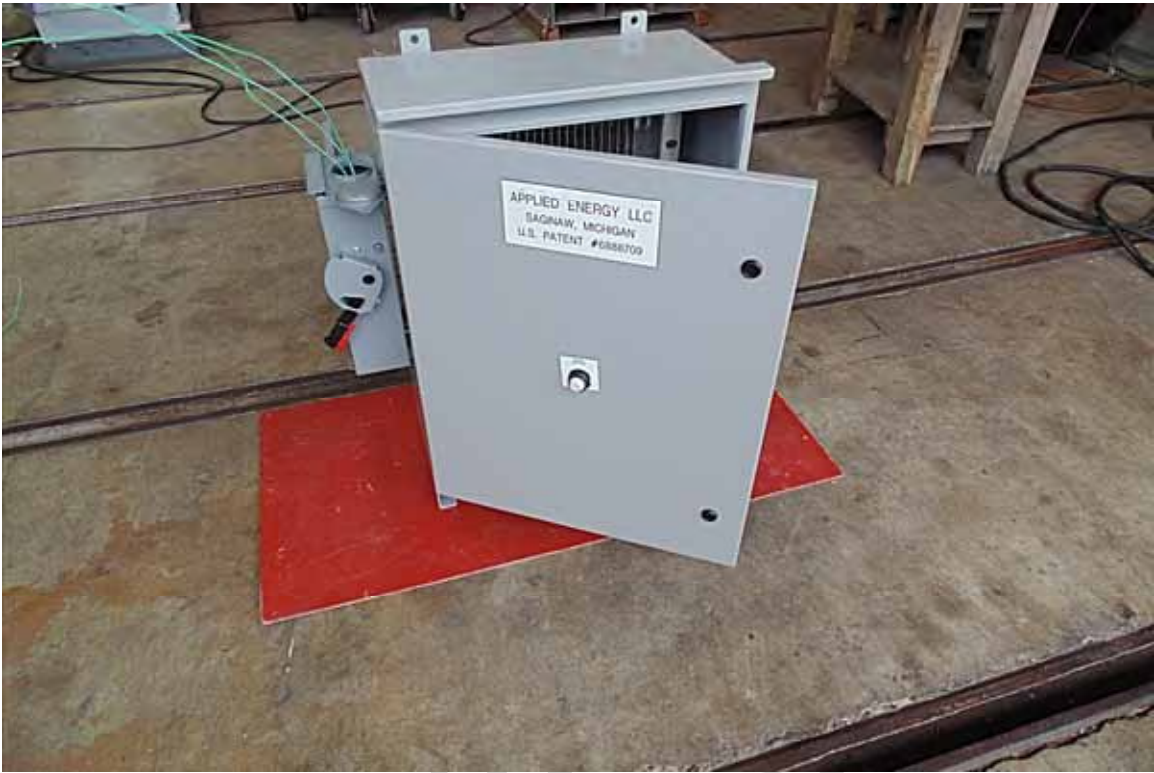

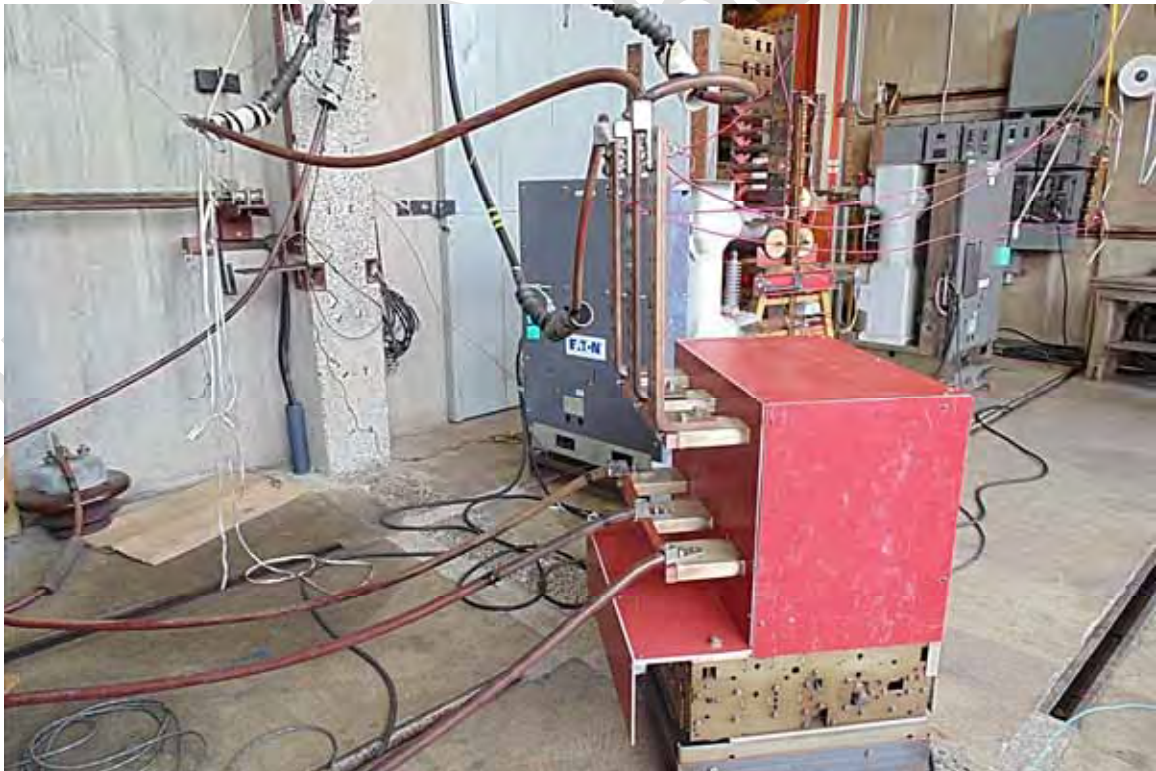



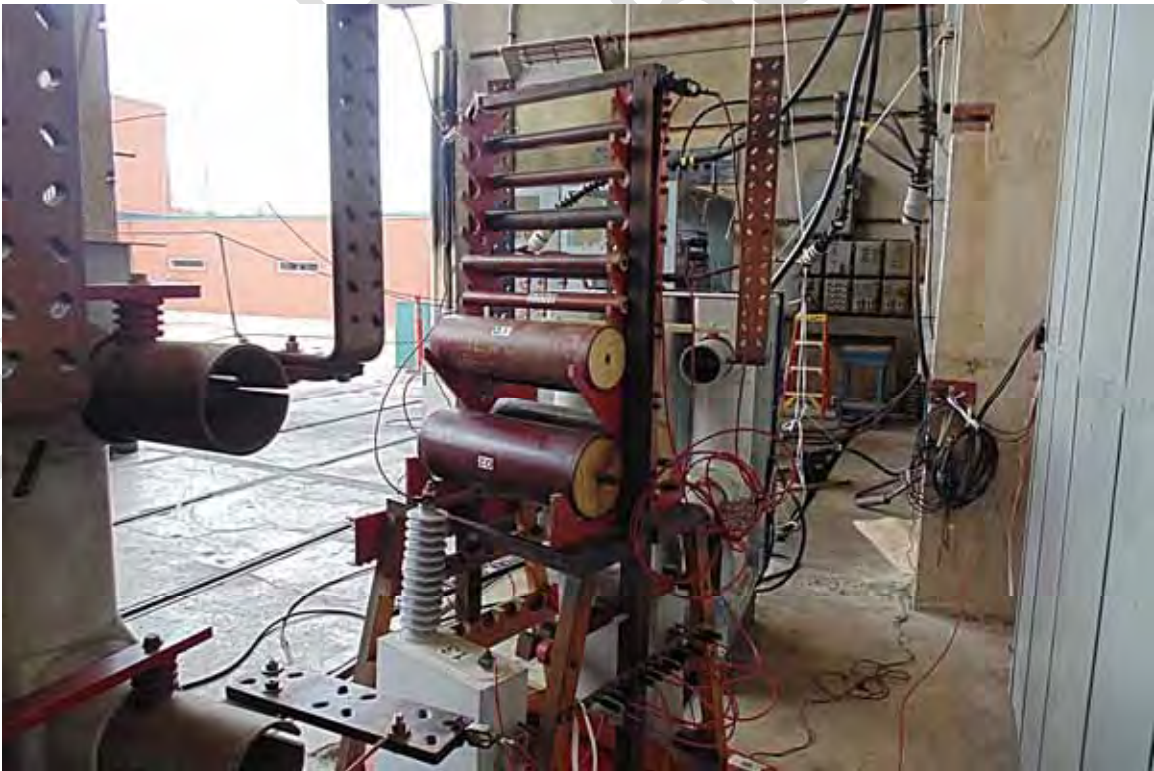
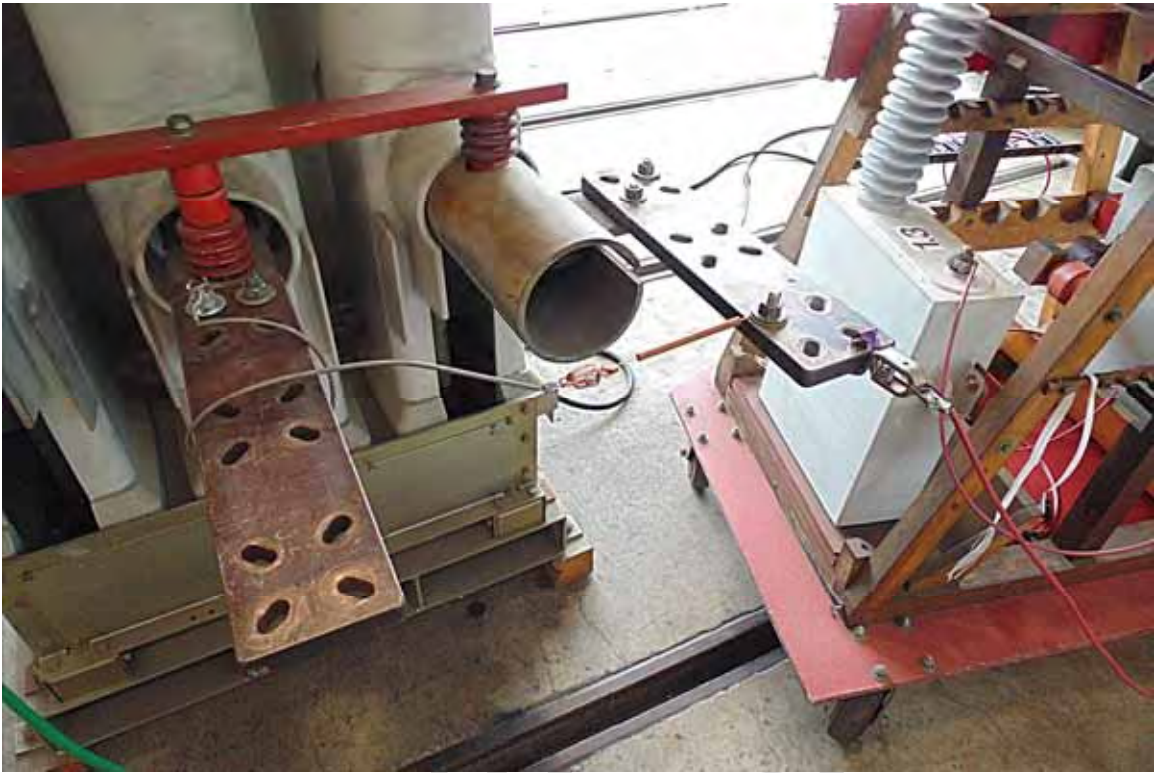

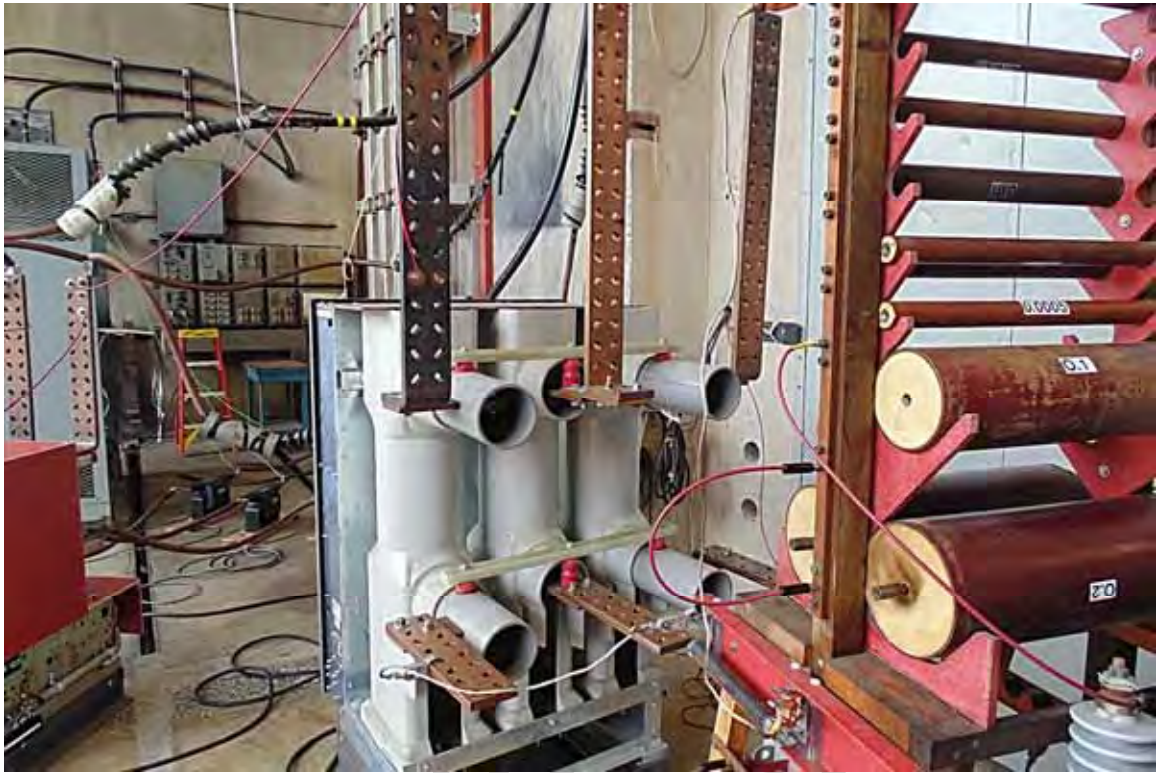





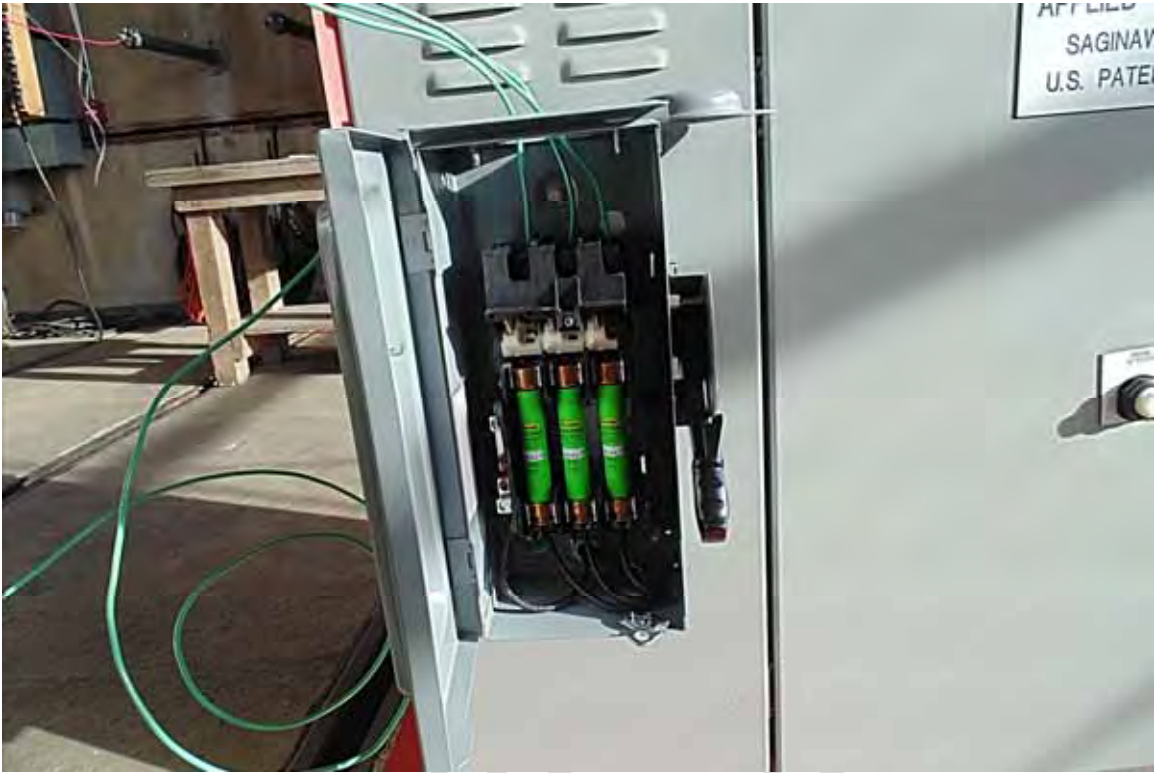

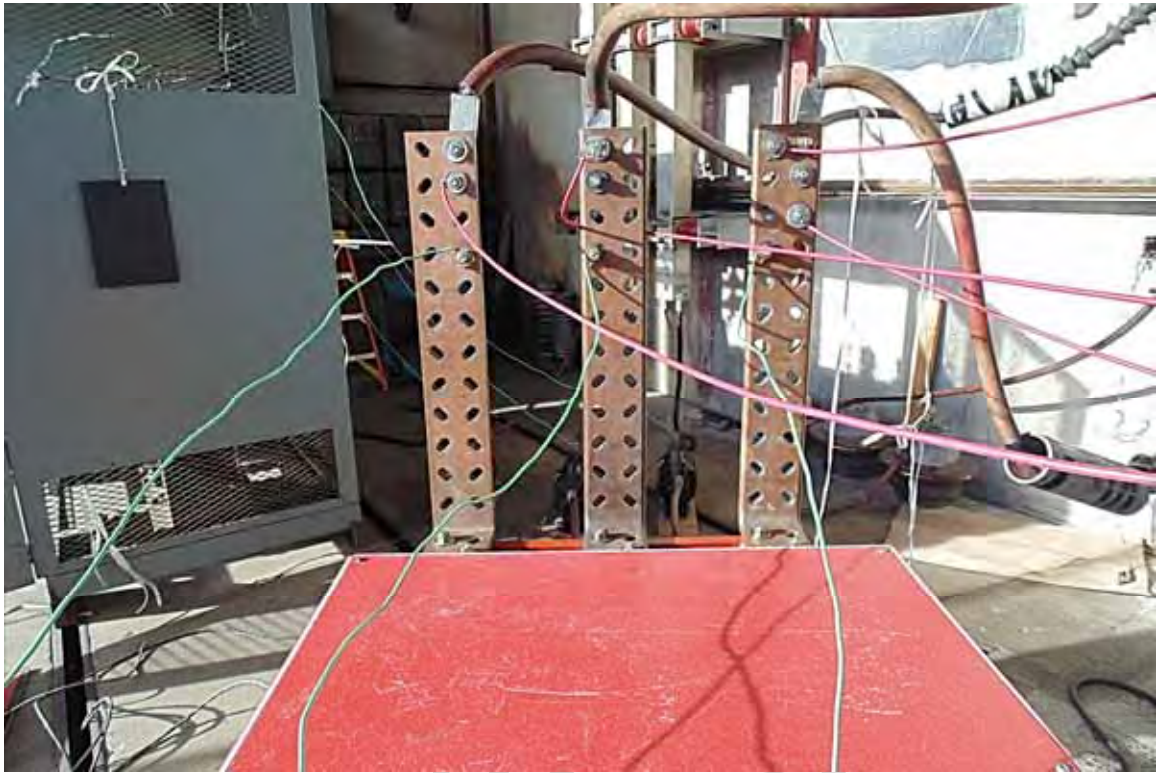







ch 13 A-N VOLT
0.001953 KV
0.6835KV/cm

ch 14 B-N VOLT
-0.007812 KV
0.6835KV/cm

ch 15 C-N VOLT
-0.01367 KV
0.6835KV/cm

Draft - Report
KEMA Laboratories

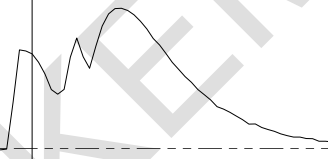

1

2

ch 13 A-N VOLT
0 KV
0.6835KV/cm

ch 14 B-N VOLT
0.003906 KV
0.6835KV/cm

ch 15 C-N VOLT
0.03125 KV
0.6835KV/cm

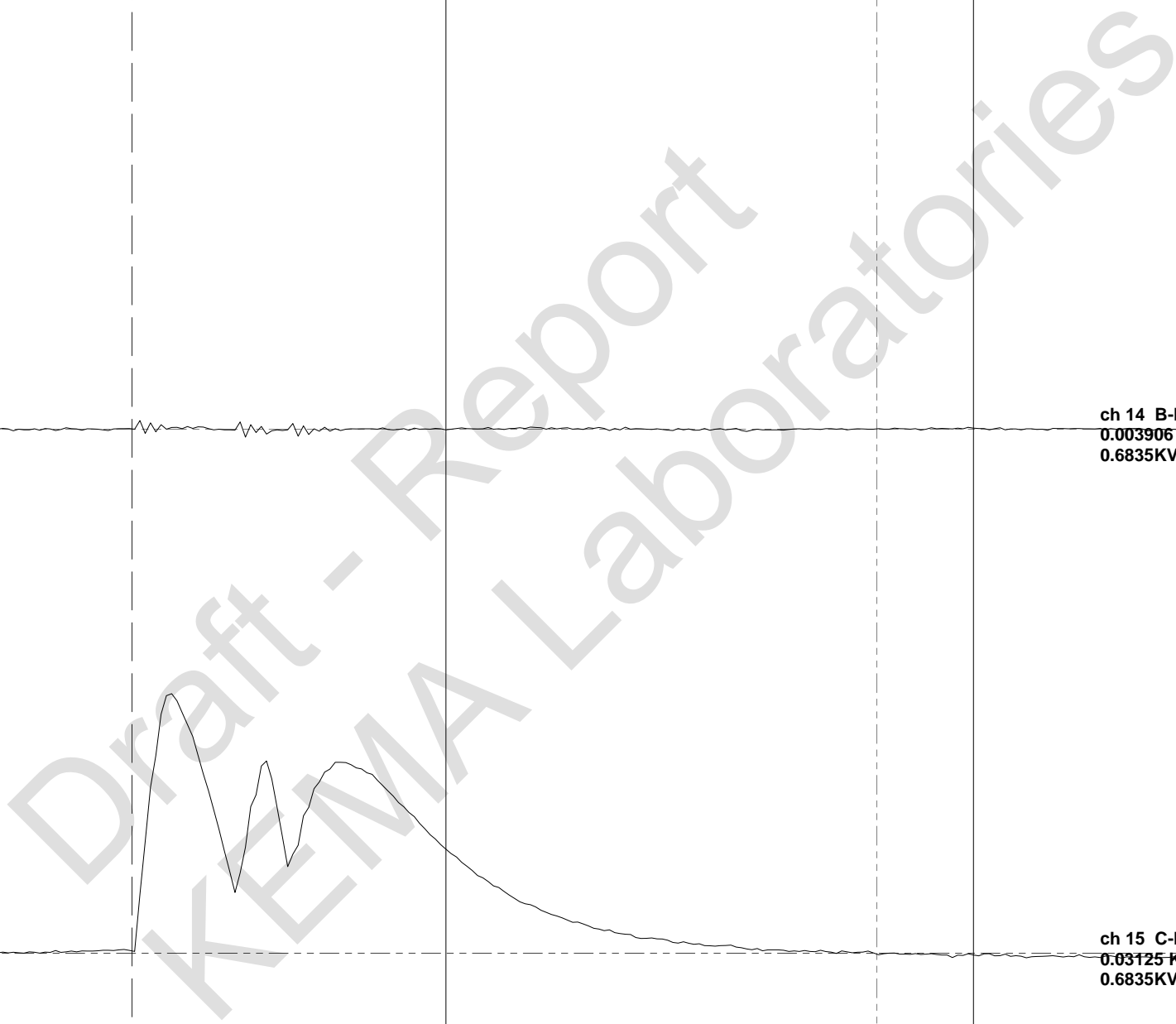

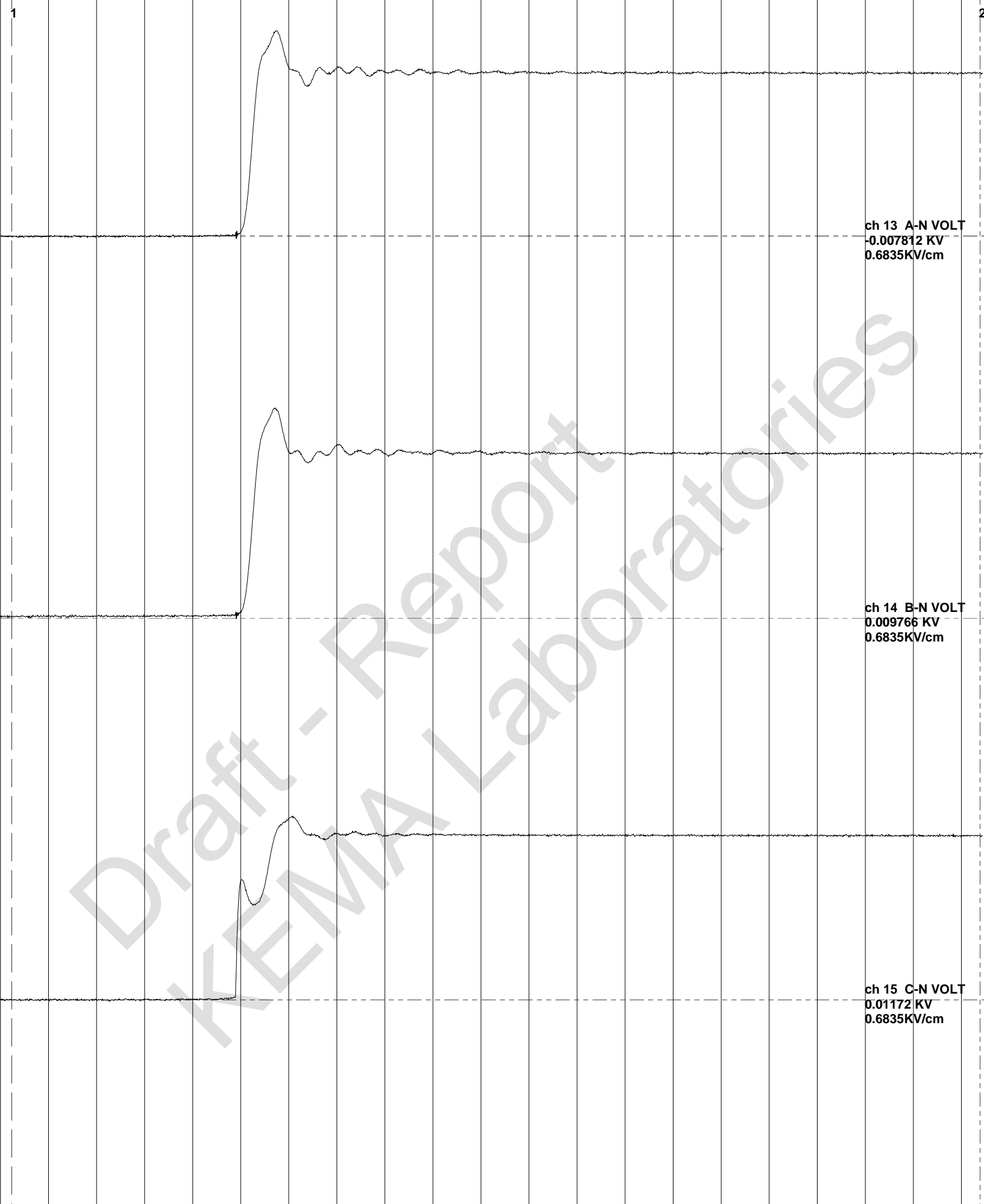

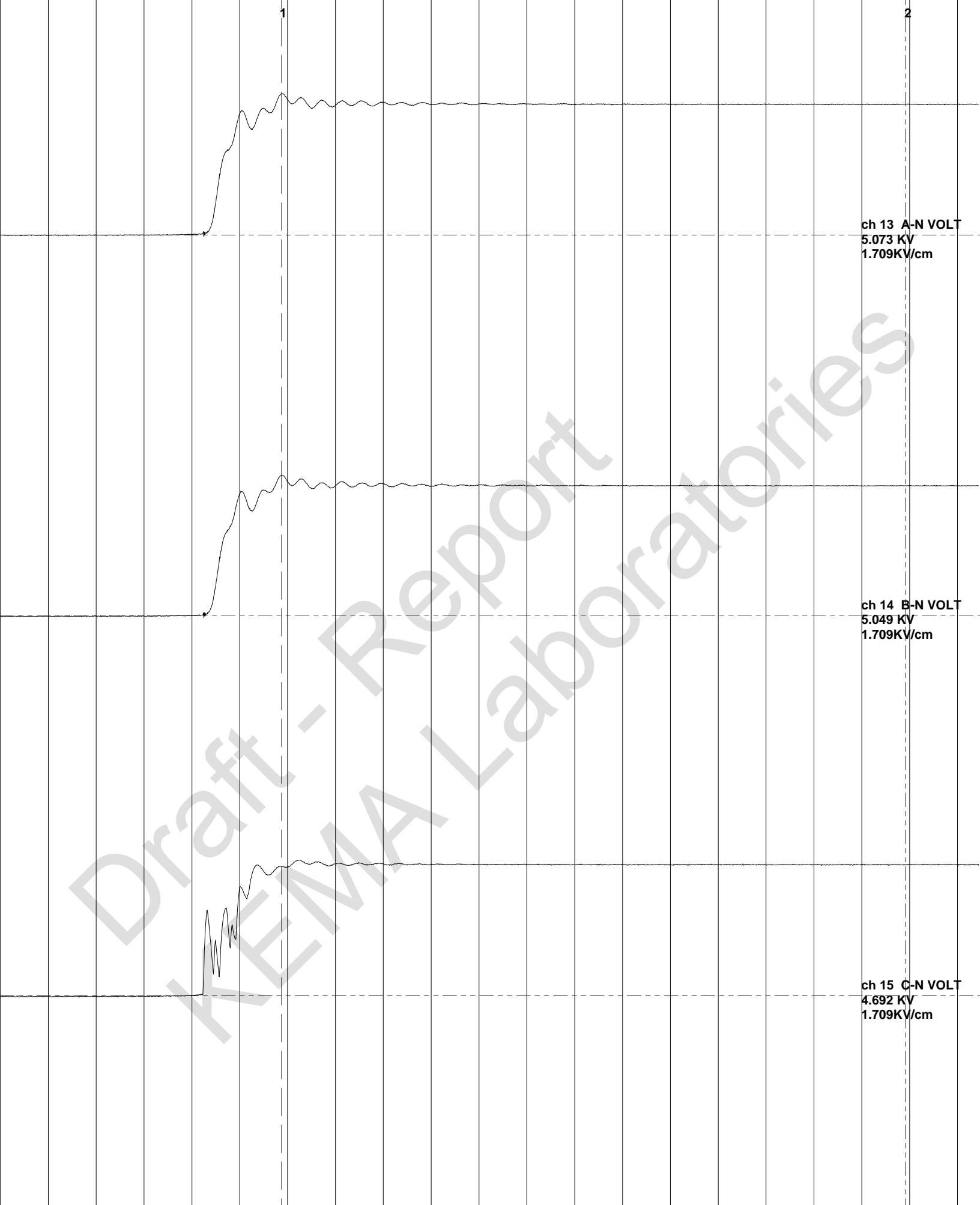

ch 13 A-N VOLT
5.073 KV
1.709KV/cm

ch 14 B-N VOLT
5.049 KV
1.709KV/cm

ch 15 C-N VOLT
4.692 KV
1.709KV/cm

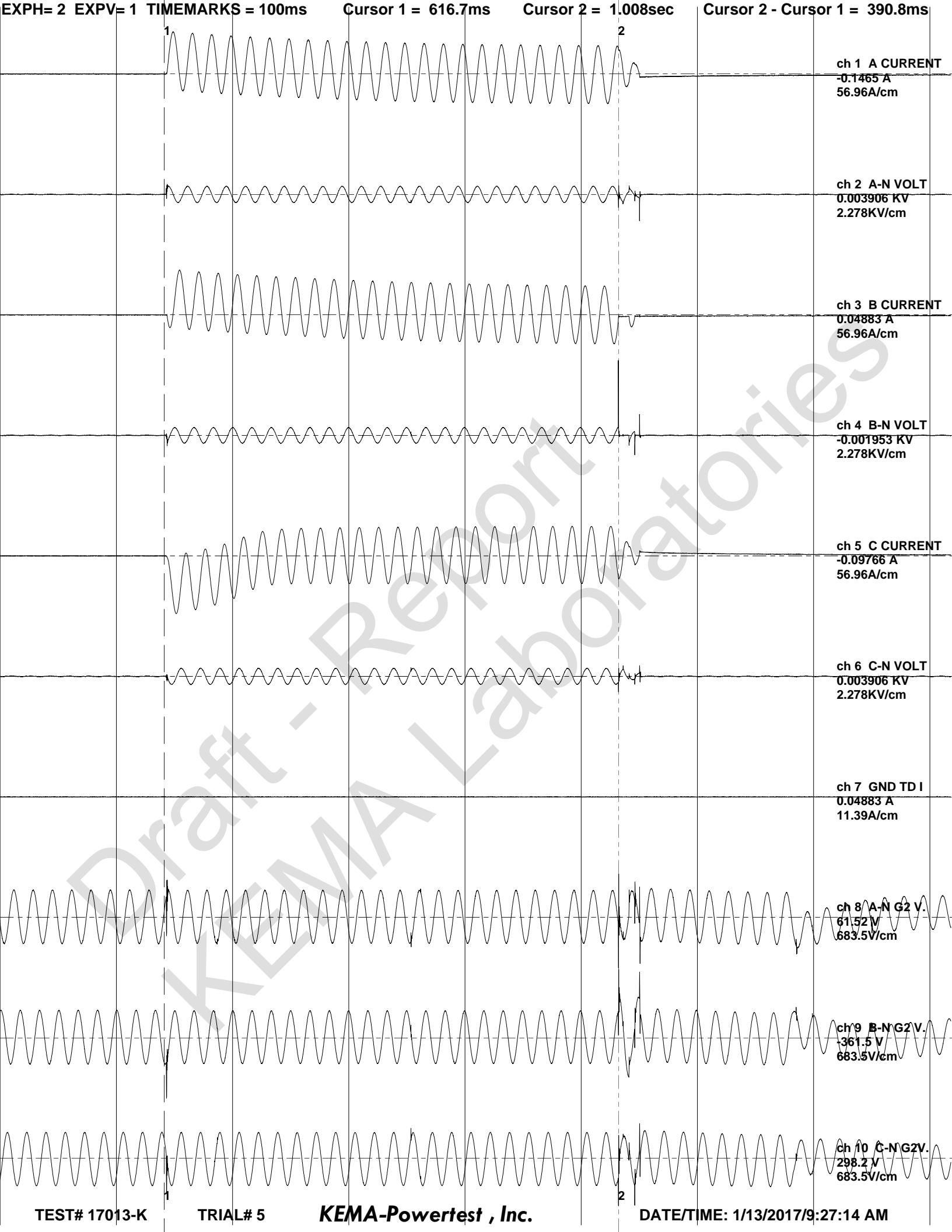

EXPH= 2 EXPV= 1 TIMEMARKS = 100ms

Cursor 1 = 616.7ms

Cursor 2 = 1.008sec

Cursor 2 - Cursor 1 = 390.8ms

ch 1 A CURRENT
-0.1465 A
56.96A/cm

ch 2 A-N VOLT
0.003906 KV
2.278KV/cm

ch 3 B CURRENT
0.04883 A
56.96A/cm

ch 4 B-N VOLT
-0.001953 KV
2.278KV/cm

ch 5 C CURRENT
-0.09766 A
56.96A/cm

ch 6 C-N VOLT
0.003906 KV
2.278KV/cm

ch 7 GND TD I
0.04883 A
11.39A/cm

ch 8 A-N G2 V.
61.52 V
683.5V/cm

ch 9 B-N G2 V.
-361.5 V
683.5V/cm

ch 10 C-N G2 V.
298.2 V
683.5V/cm

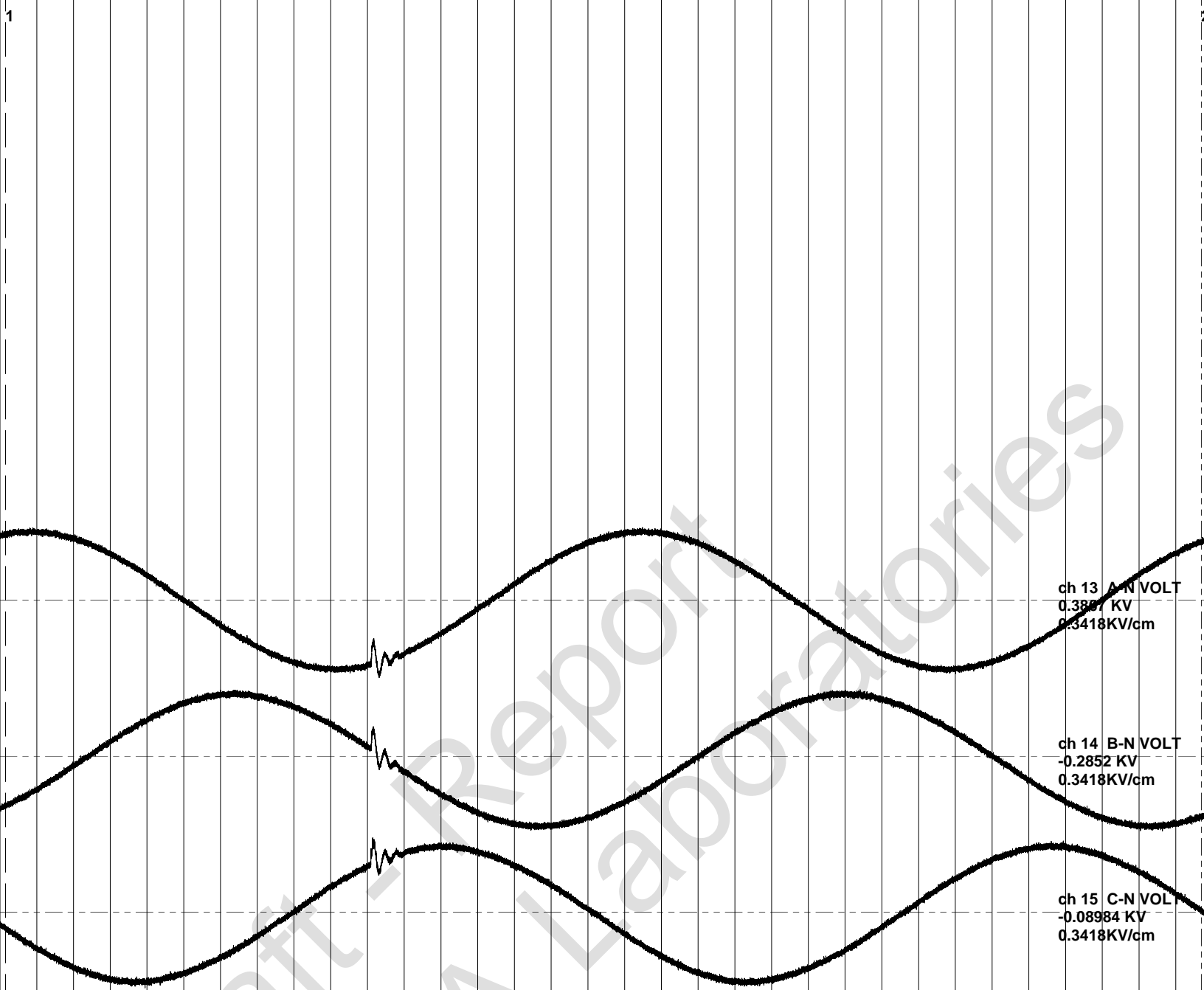

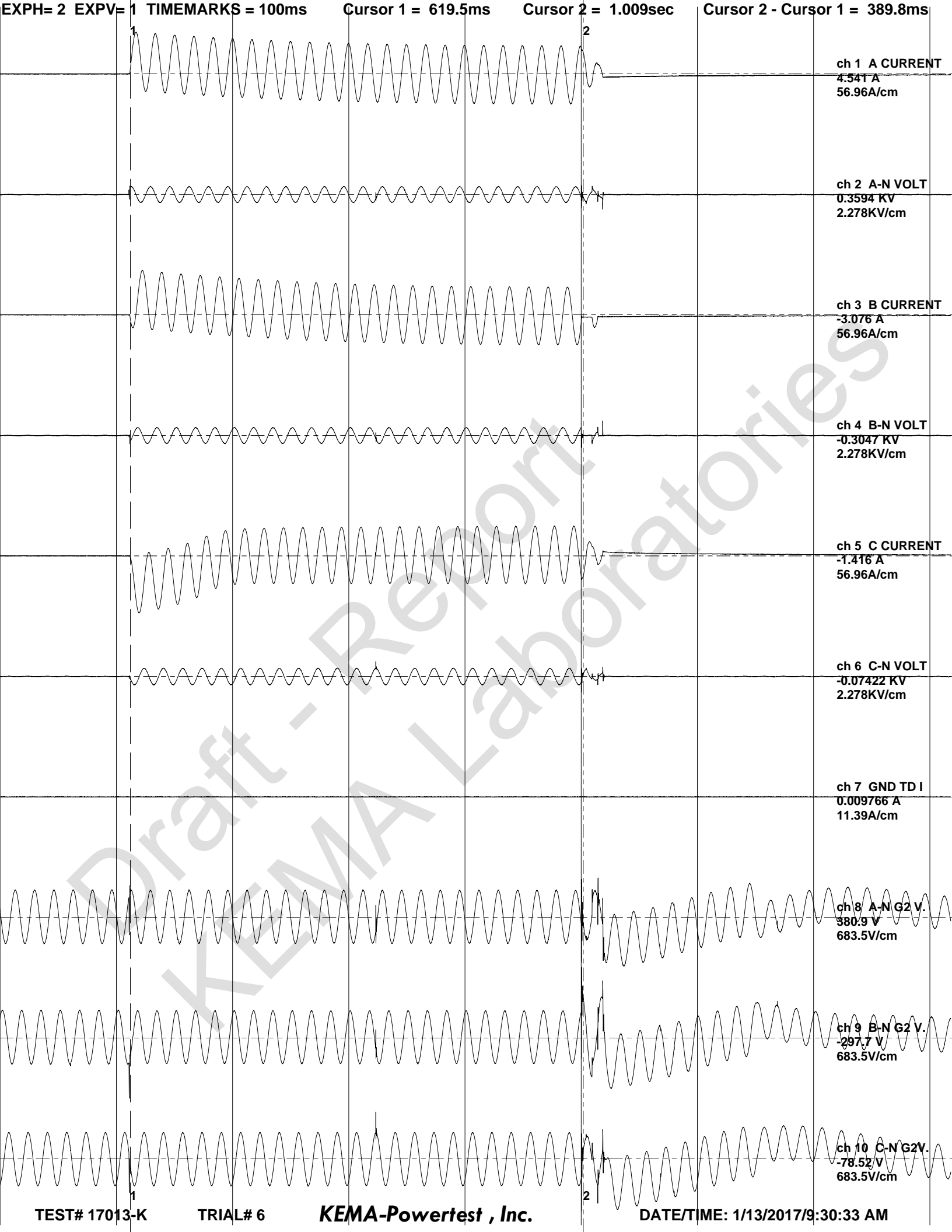

EXPH= 2 EXPV= 1

TIMEMARKS = 100ms

Cursor 1 = 619.5ms

Cursor 2 = 1.009sec

Cursor 2 - Cursor 1 = 389.8ms

ch 1 A CURRENT
4.541 A
56.96A/cm

ch 2 A-N VOLT
0.3594 KV
2.278KV/cm

ch 3 B CURRENT
-3.076 A
56.96A/cm

ch 4 B-N VOLT
-0.3047 KV
2.278KV/cm

ch 5 C CURRENT
-1.416 A
56.96A/cm

ch 6 C-N VOLT
-0.07422 KV
2.278KV/cm

ch 7 GND TD I
0.009766 A
11.39A/cm

ch 8 A-N G2 V.
380.9 V
683.5V/cm

ch 9 B-N G2 V.
-297.7 V
683.5V/cm

ch 10 C-N G2 V.
-78.52 V
683.5V/cm

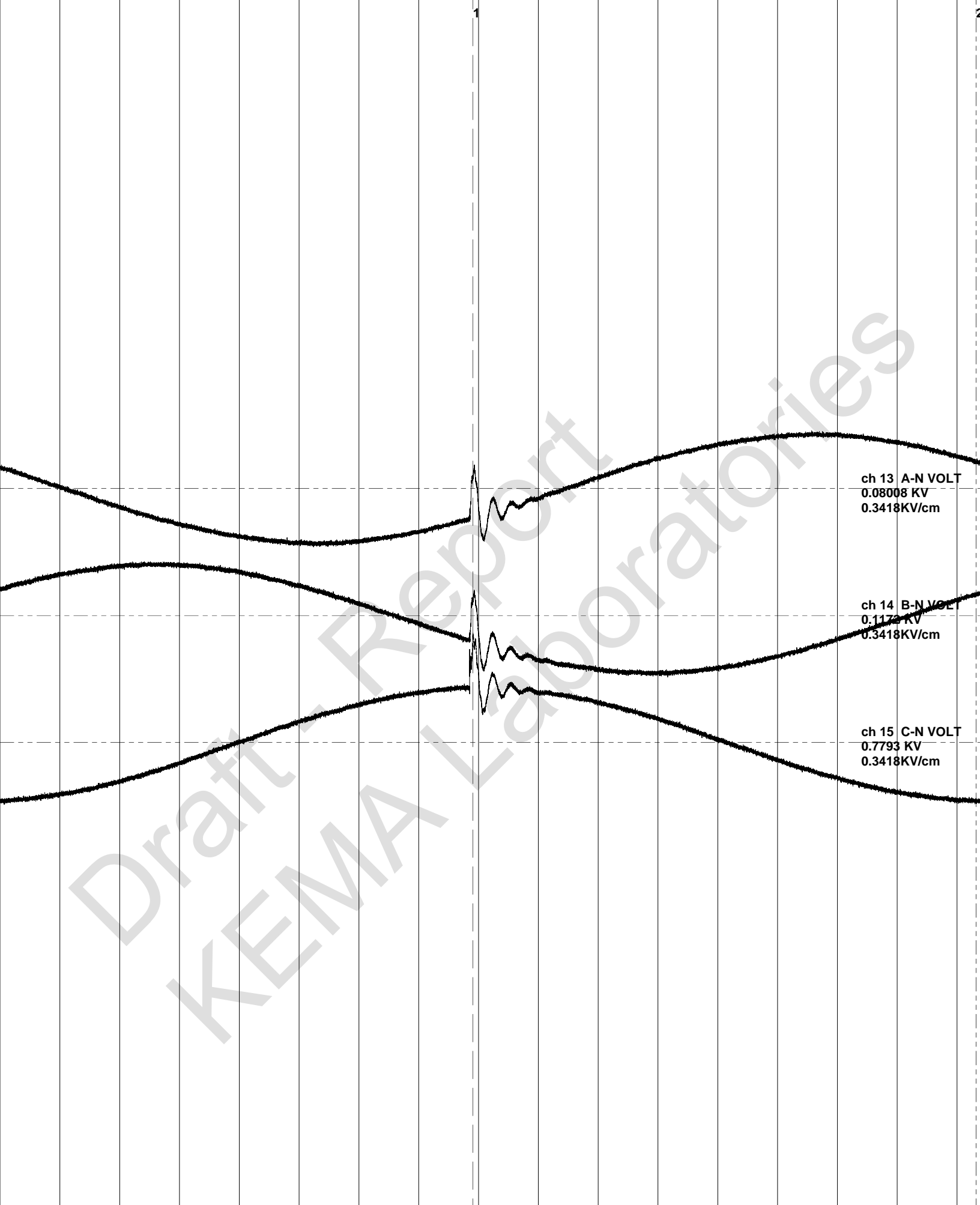

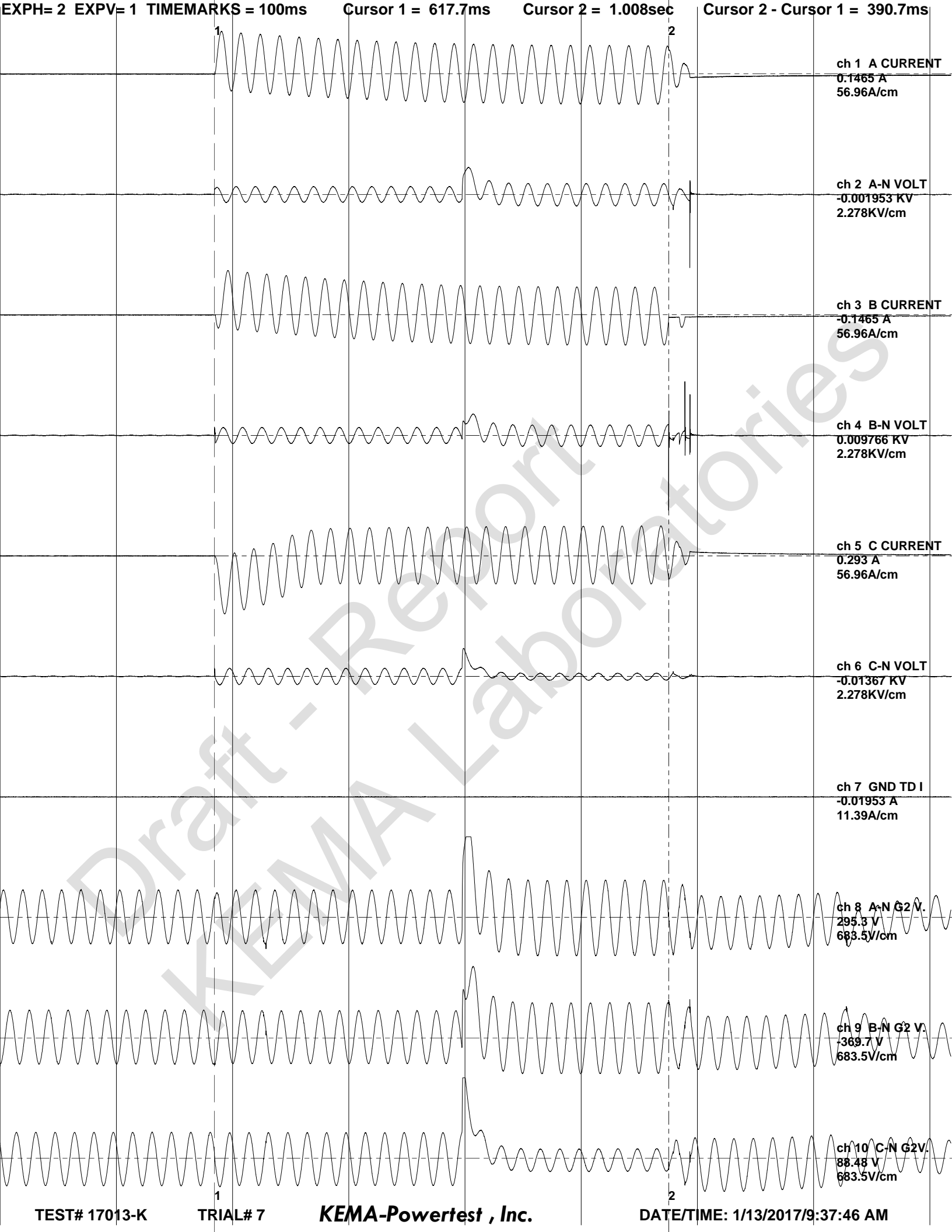

EXPH= 2 EXPV= 1 TIMEMARKS = 100ms

Cursor 1 = 617.7ms

Cursor 2 = 1.008sec

Cursor 2 - Cursor 1 = 390.7ms

ch 1 A CURRENT
0.1465 A
56.96A/cm

ch 2 A-N VOLT
-0.001953 KV
2.278KV/cm

ch 3 B CURRENT
-0.1465 A
56.96A/cm

ch 4 B-N VOLT
0.009766 KV
2.278KV/cm

ch 5 C CURRENT
0.293 A
56.96A/cm

ch 6 C-N VOLT
-0.01367 KV
2.278KV/cm

ch 7 GND TD I
-0.01953 A
11.39A/cm

ch 8 A-N G2 V.
295.3 V
683.5V/cm

ch 9 B-N G2 V.
-369.7 V
683.5V/cm

ch 10 C-N G2 V.
88.48 V
683.5V/cm

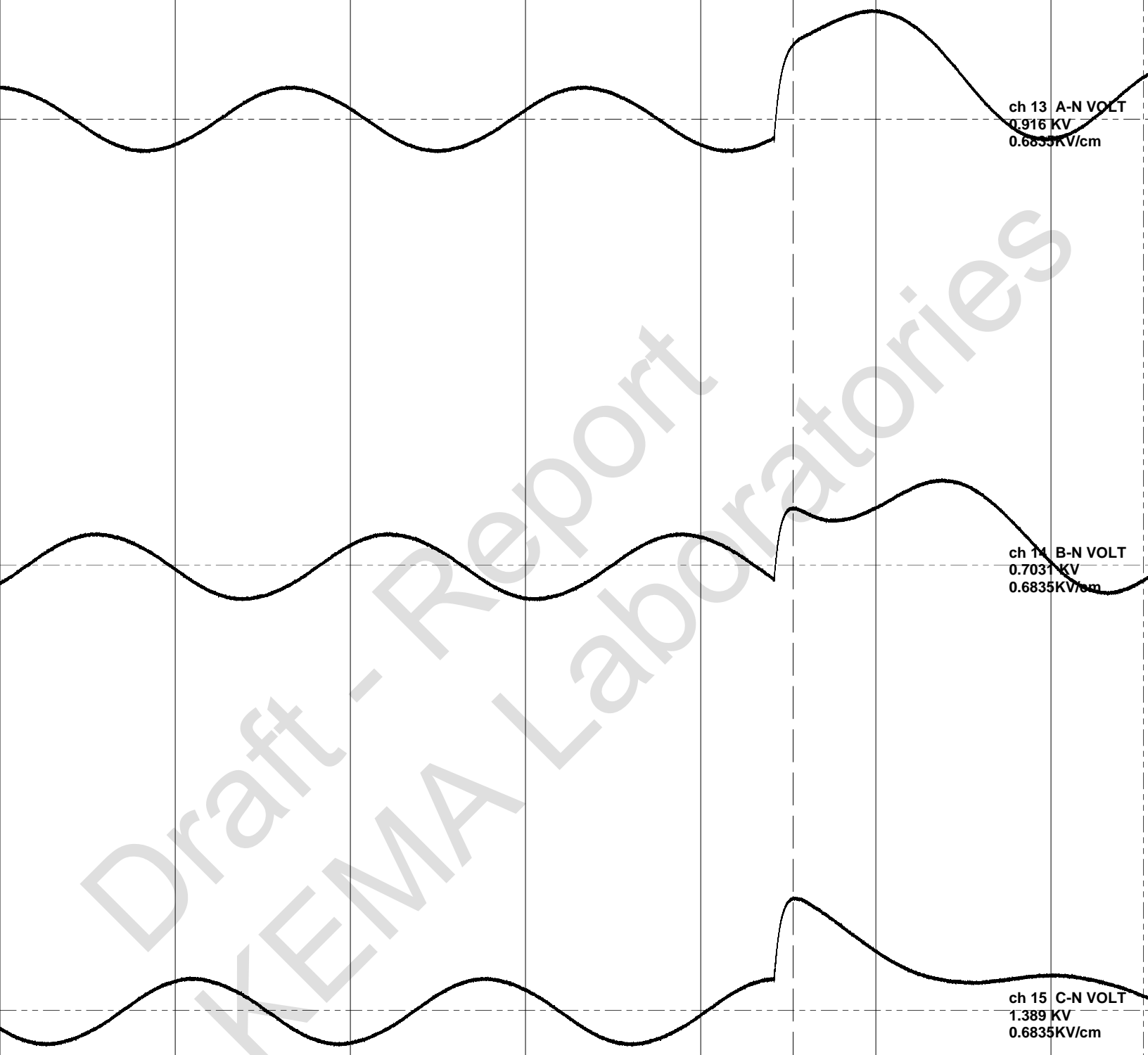

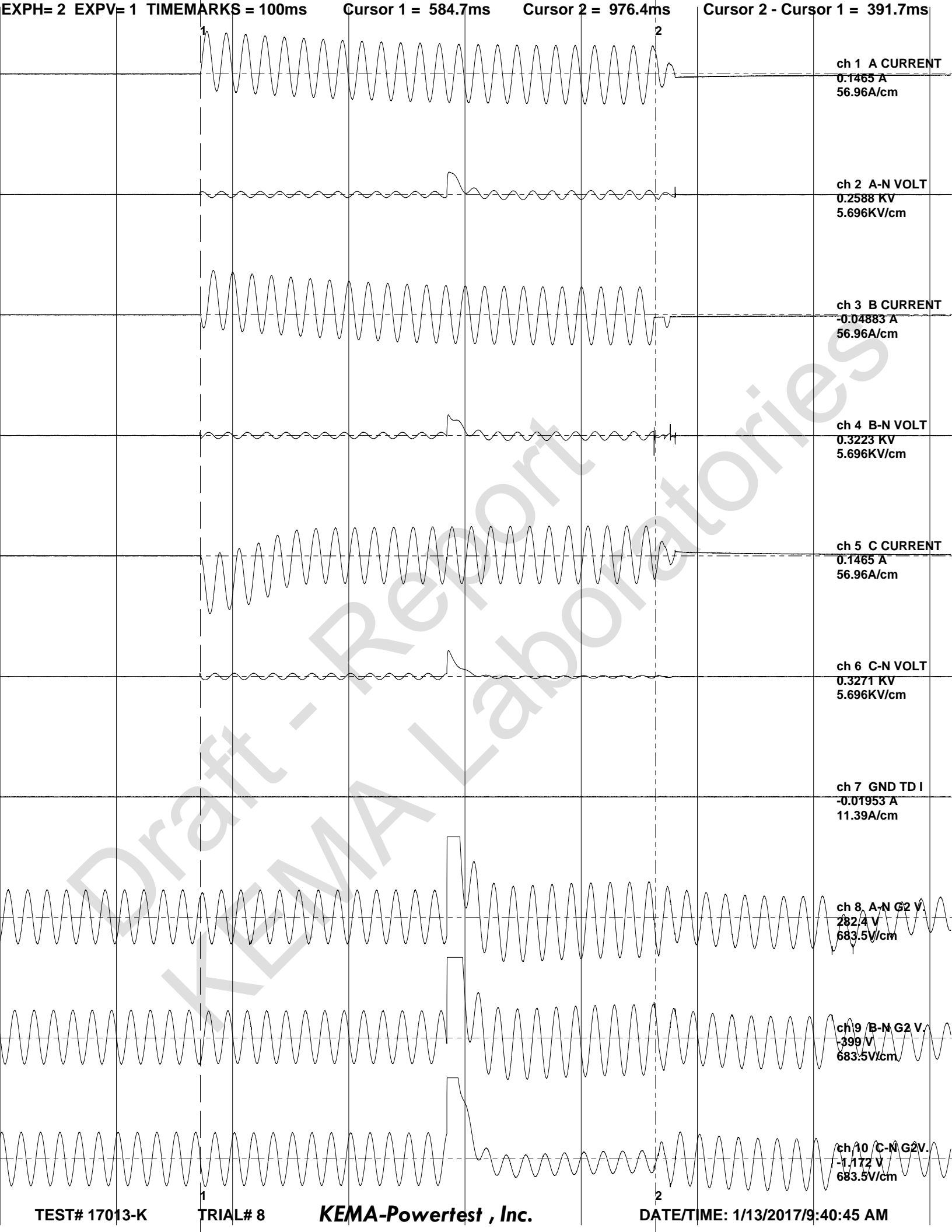

EXPH= 2 EXPV= 1 TIMEMARKS = 100ms

Cursor 1 = 584.7ms

Cursor 2 = 976.4ms

Cursor 2 - Cursor 1 = 391.7ms

ch 1 A CURRENT
0.1465 A
56.96A/cm

ch 2 A-N VOLT
0.2588 KV
5.696KV/cm

ch 3 B CURRENT
-0.04883 A
56.96A/cm

ch 4 B-N VOLT
0.3223 KV
5.696KV/cm

ch 5 C CURRENT
0.1465 A
56.96A/cm

ch 6 C-N VOLT
0.3271 KV
5.696KV/cm

ch 7 GND TD I
-0.01953 A
11.39A/cm

ch 8 A-N G2 V
282.4 V
683.5V/cm

ch 9 B-N G2 V
-399 V
683.5V/cm

ch 10 C-N G2 V
-1.172 V
683.5V/cm

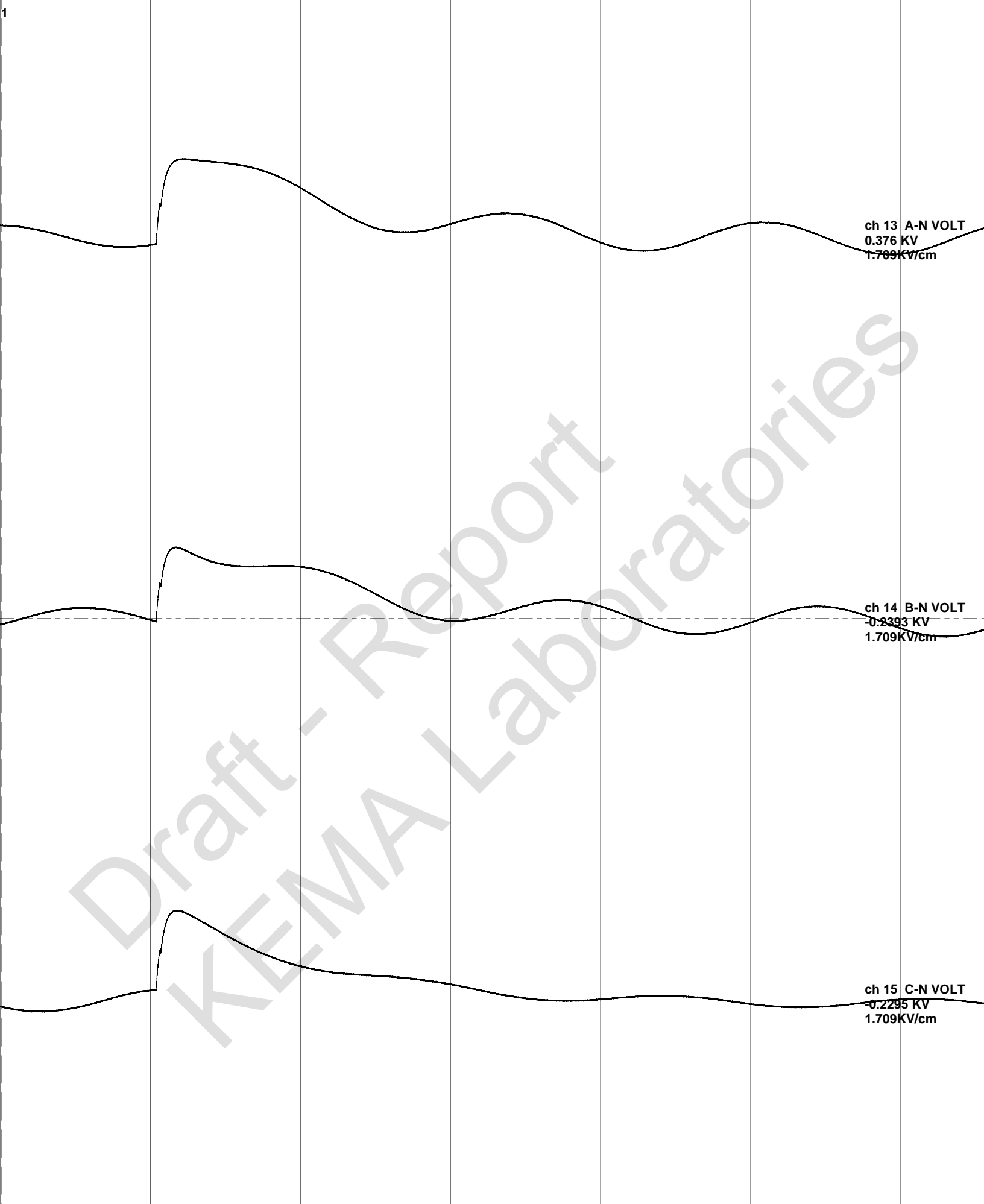

ch 13 A-N VOLT
0.376 KV
1.709KV/cm

ch 14 B-N VOLT
-0.2393 KV
1.709KV/cm

ch 15 C-N VOLT
-0.2295 KV
1.709KV/cm

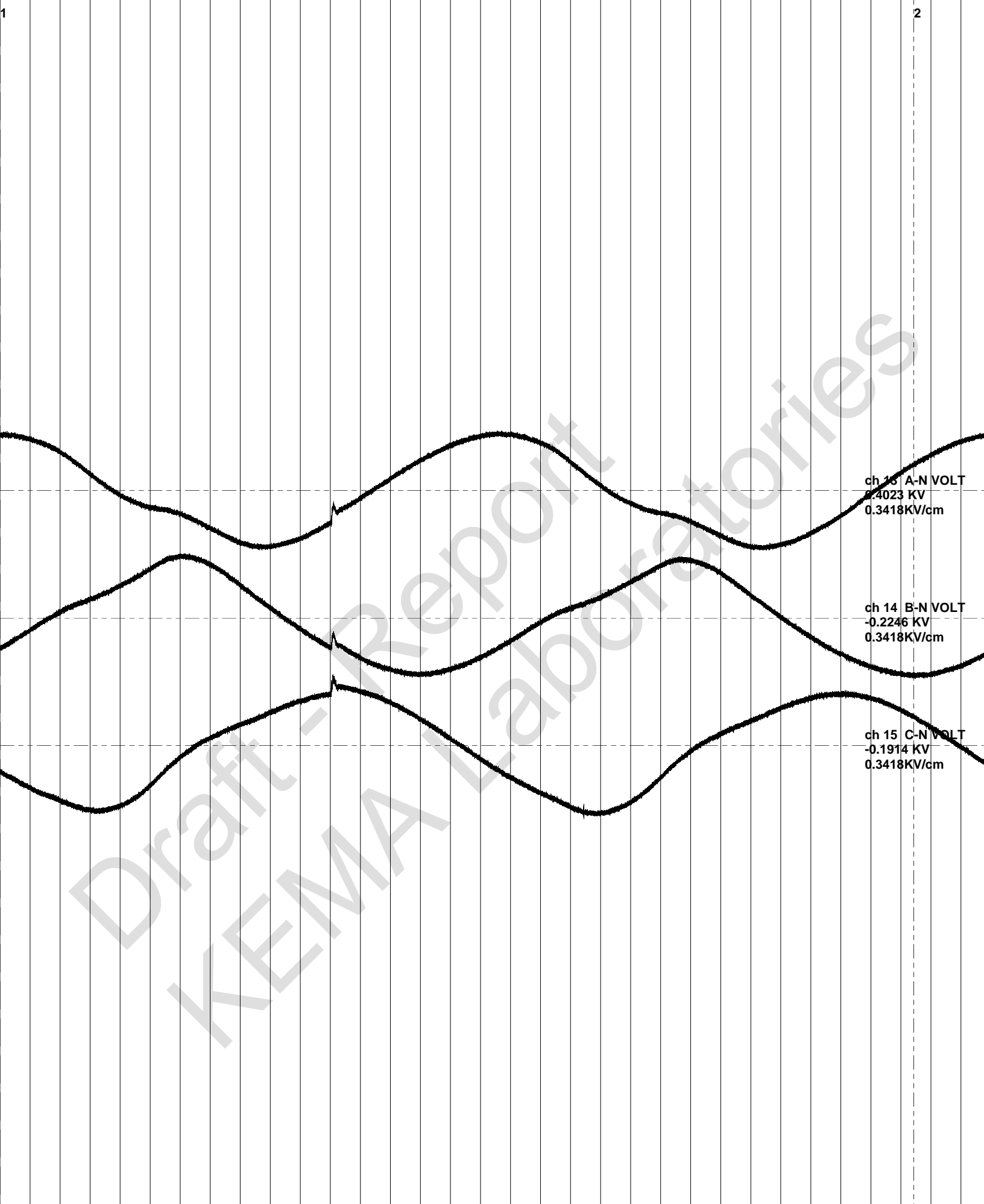

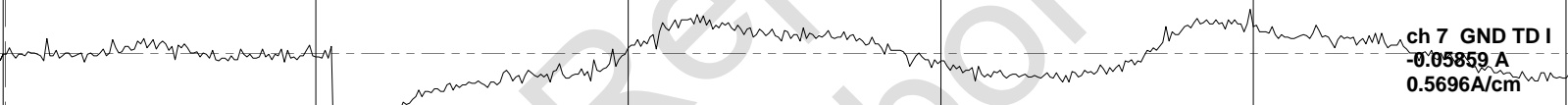

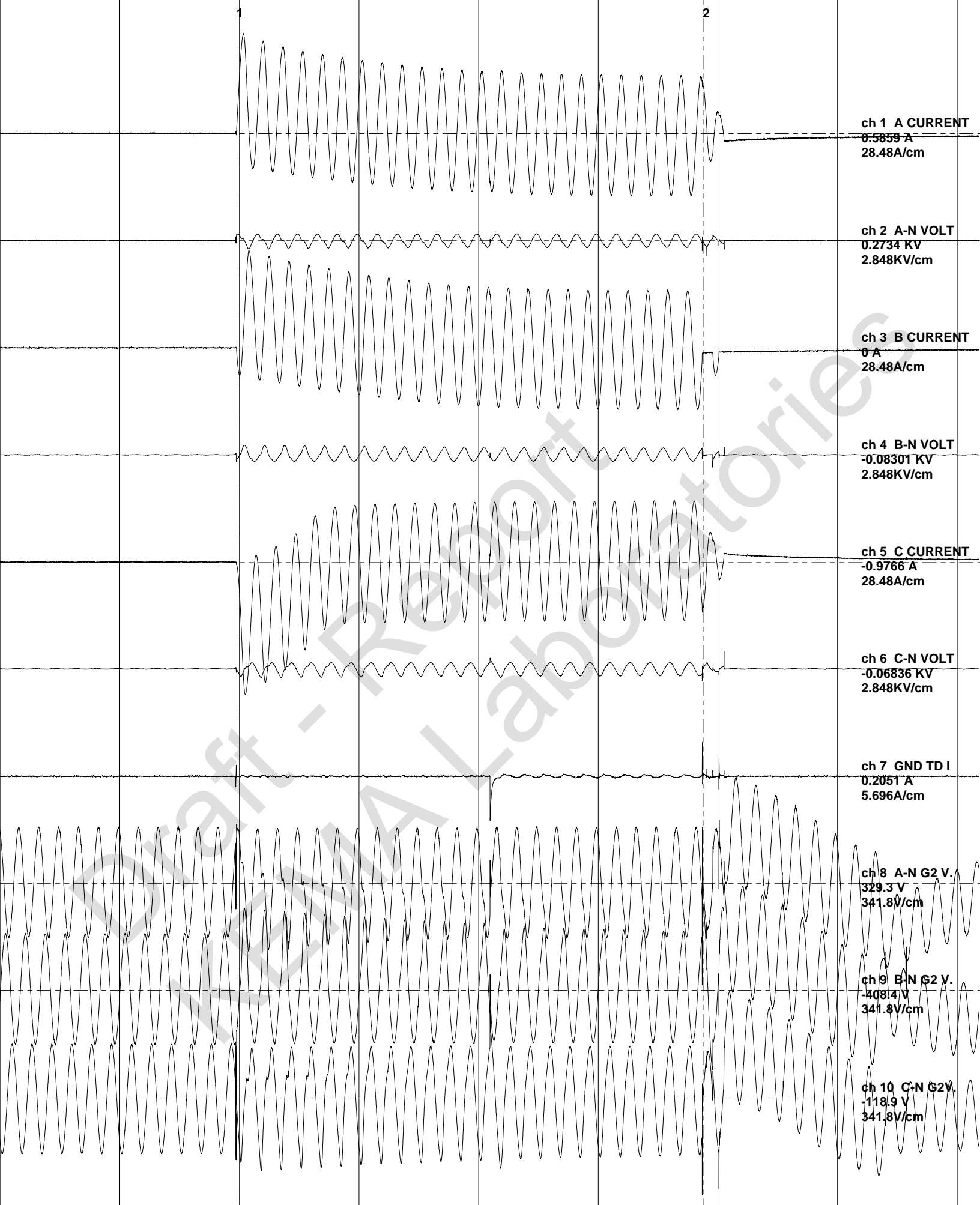

ch 1 A CURRENT
0.5859 A
28.48A/cm

ch 2 A-N VOLT
0.2734 KV
2.848KV/cm

ch 3 B CURRENT
0 A
28.48A/cm

ch 4 B-N VOLT
-0.08301 KV
2.848KV/cm

ch 5 C CURRENT
-0.9766 A
28.48A/cm

ch 6 C-N VOLT
-0.06836 KV
2.848KV/cm

ch 7 GND TD I
0.2051 A
5.696A/cm

ch 8 A-N G2 V.
329.3 V
341.8V/cm

ch 9 B-N G2 V.
-408.4 V
341.8V/cm

ch 10 C-N G2 V.
-118.9 V
341.8V/cm

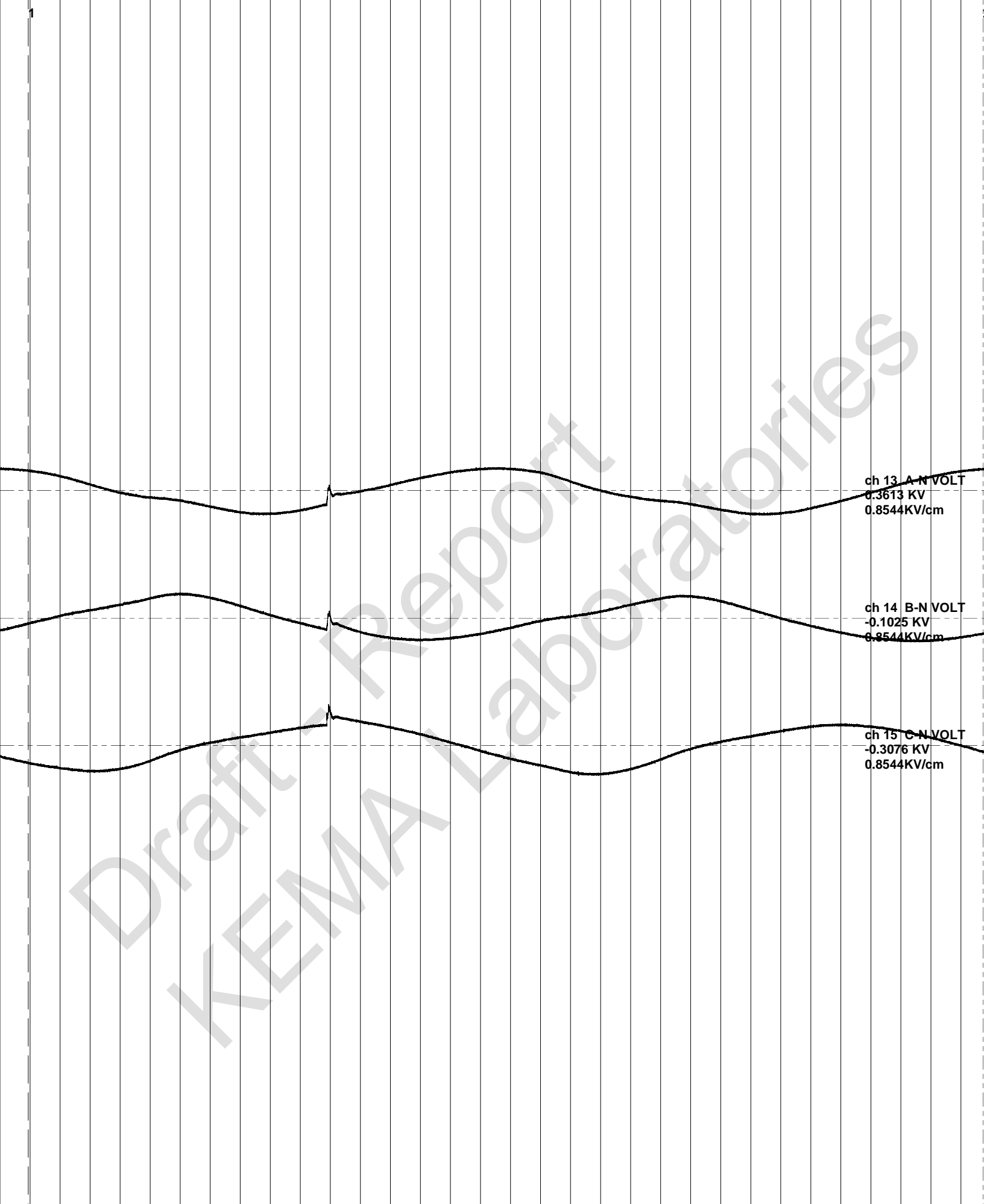

ch 13 A-N VOLT
0.3613 KV
0.8544KV/cm

ch 14 B-N VOLT
-0.1025 KV
0.8544KV/cm

ch 15 C-N VOLT
-0.3076 KV
0.8544KV/cm

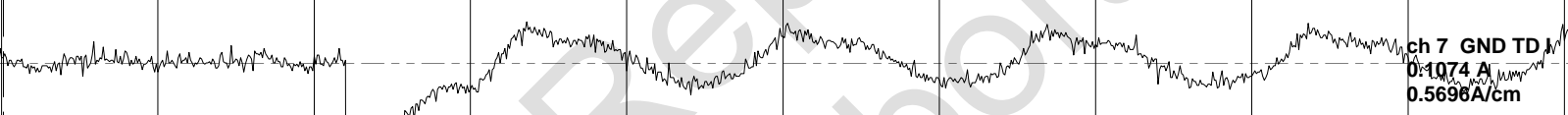

Draft - Report
KEMA Laboratories

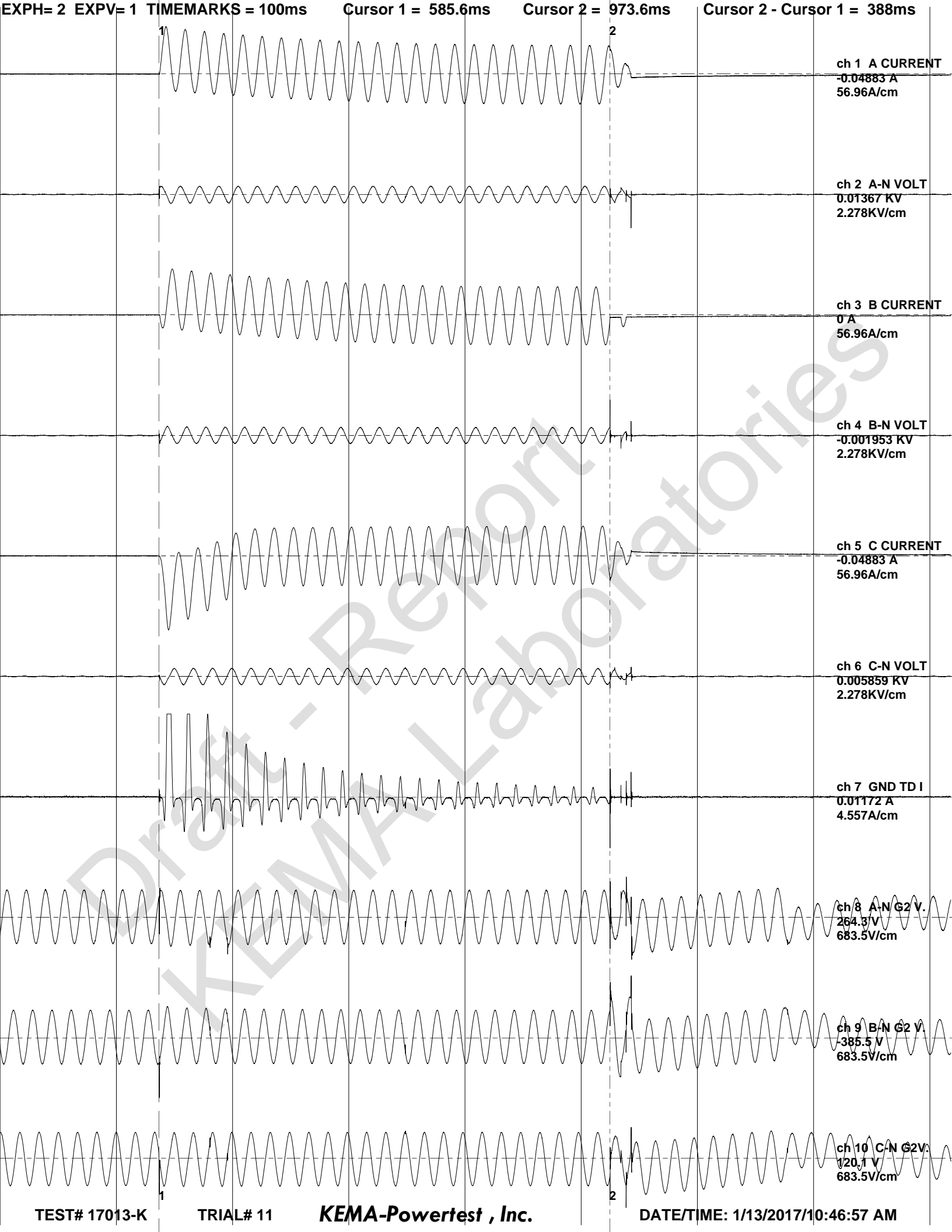

EXPH= 2 EXPV= 1 TIMEMARKS = 100ms Cursor 1 = 585.6ms Cursor 2 = 973.6ms Cursor 2 - Cursor 1 = 388ms

ch 1 A CURRENT
-0.04883 A
56.96A/cm

ch 2 A-N VOLT
0.01367 KV
2.278KV/cm

ch 3 B CURRENT
0 A
56.96A/cm

ch 4 B-N VOLT
-0.001953 KV
2.278KV/cm

ch 5 C CURRENT
-0.04883 A
56.96A/cm

ch 6 C-N VOLT
0.005859 KV
2.278KV/cm

ch 7 GND TD I
0.01172 A
4.557A/cm

ch 8 A-N G2 V.
264.3 V
683.5V/cm

ch 9 B-N G2 V.
385.5 V
683.5V/cm

ch 10 C-N G2V.
120.1 V
683.5V/cm

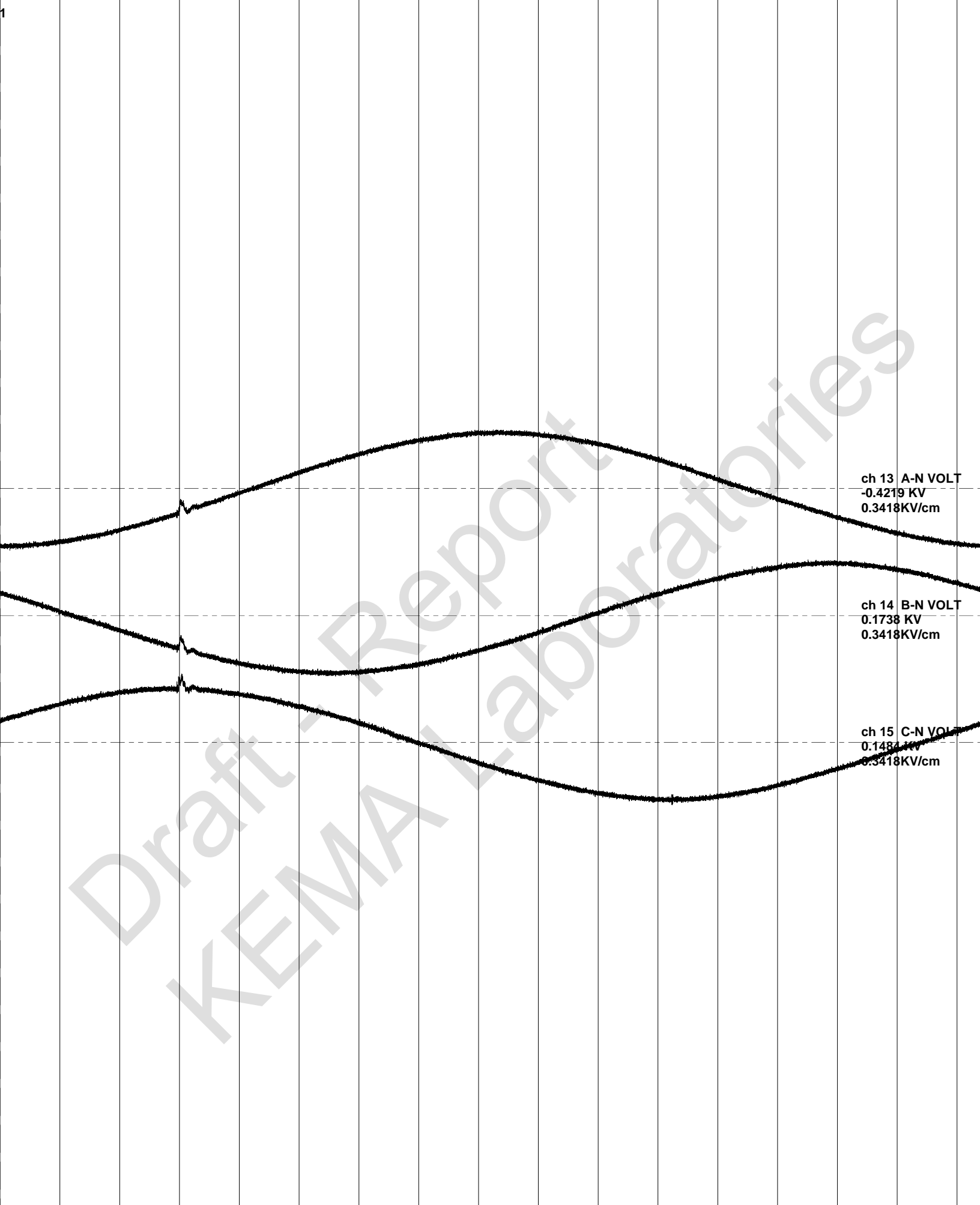

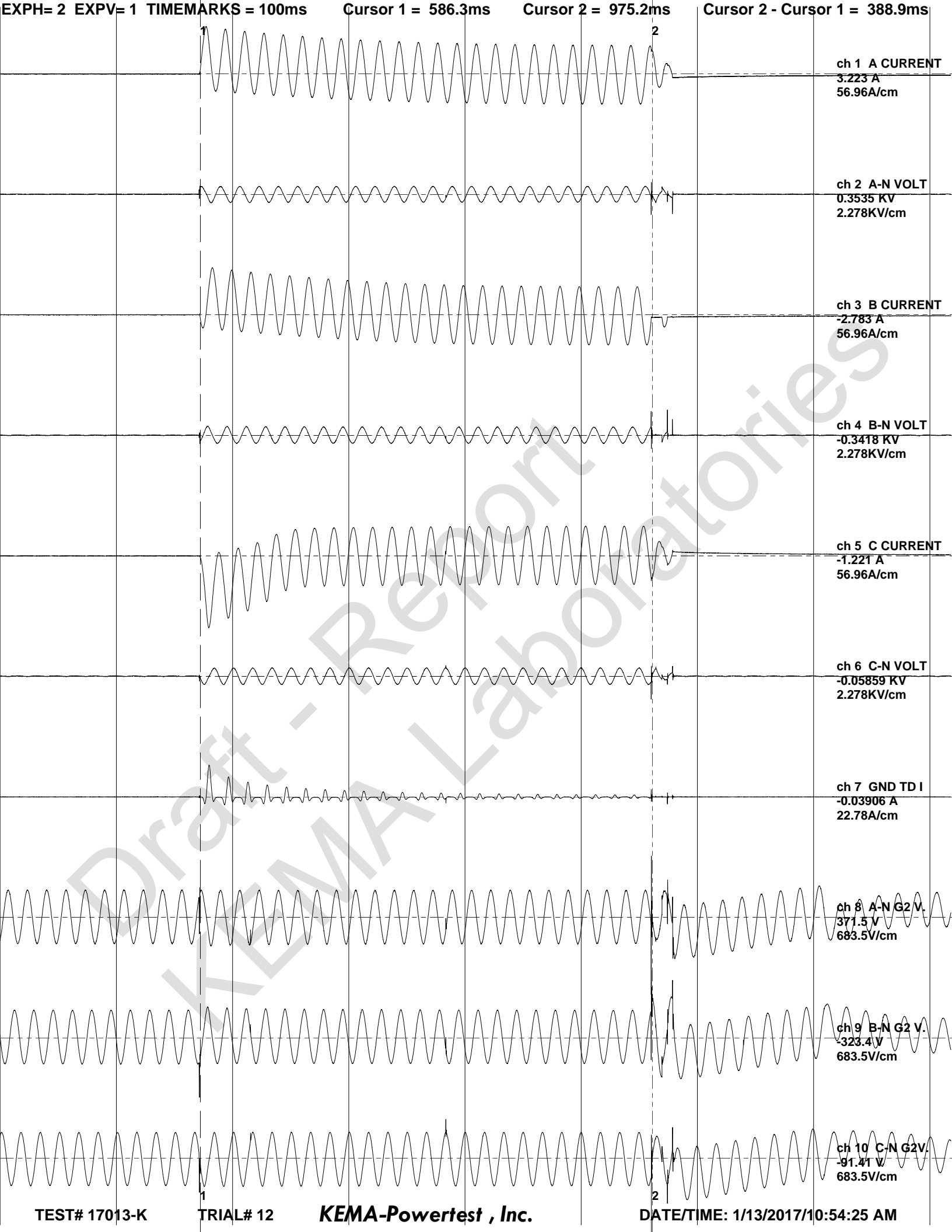

EXPH= 2 EXPV= 1 TIMEMARKS = 100ms

Cursor 1 = 586.3ms

Cursor 2 = 975.3ms

Cursor 2 - Cursor 1 = 388.9ms

ch 1 A CURRENT
3.223 A
56.96A/cm

ch 2 A-N VOLT
0.3535 KV
2.278KV/cm

ch 3 B CURRENT
-2.783 A
56.96A/cm

ch 4 B-N VOLT
-0.3418 KV
2.278KV/cm

ch 5 C CURRENT
-1.221 A
56.96A/cm

ch 6 C-N VOLT
-0.05859 KV
2.278KV/cm

ch 7 GND TD I
-0.03906 A
22.78A/cm

ch 8 A-N G2 V.
371.5 V
683.5V/cm

ch 9 B-N G2 V.
323.4 V
683.5V/cm

ch 10 C-N G2V.
-91.41 V
683.5V/cm

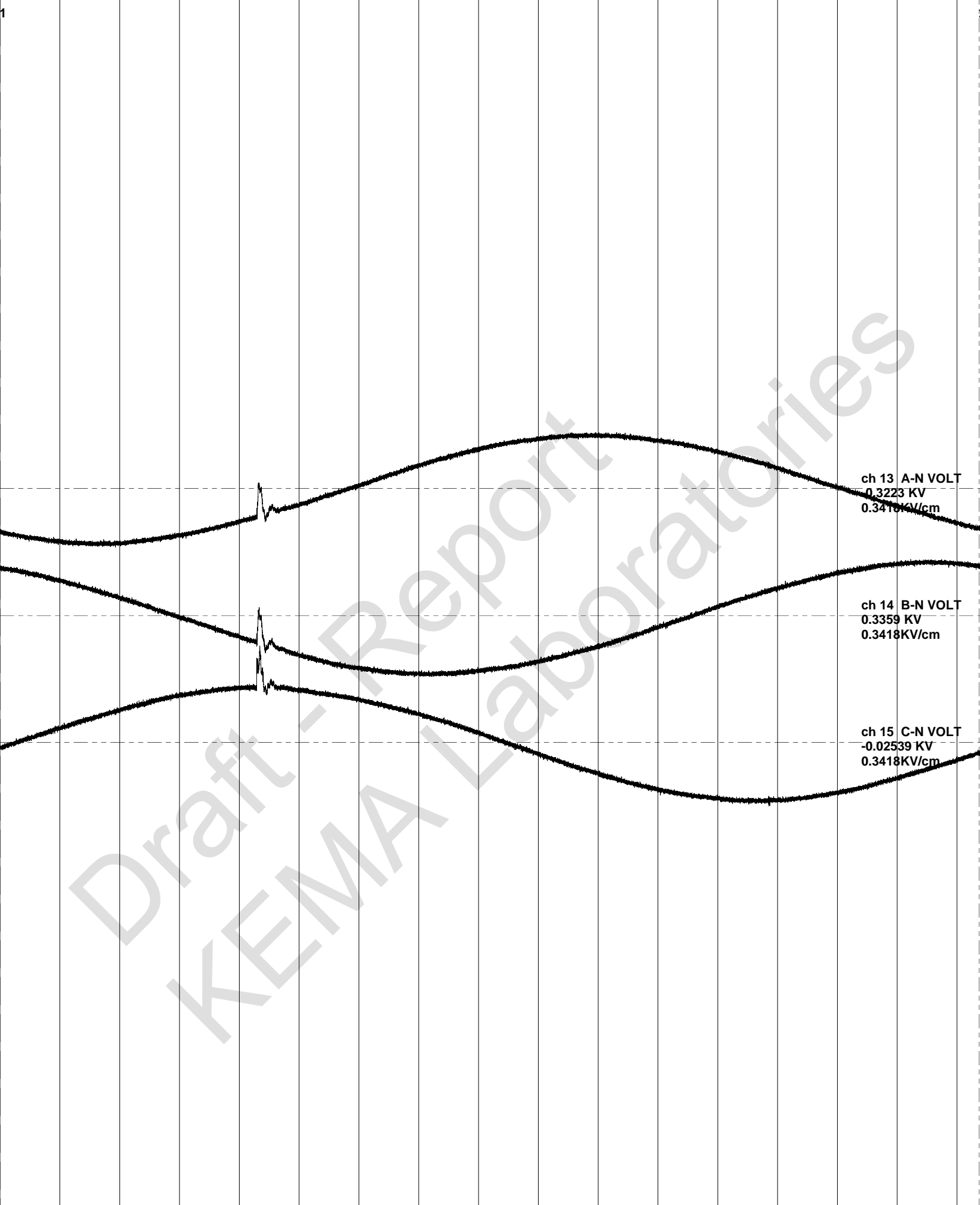

END OF DOCUMENT