

IEC CONTACTORS / RELAYS

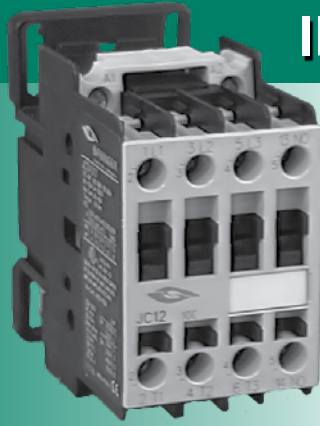
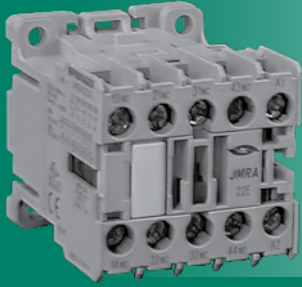

SPRINGER
controls company

Springer Controls carries a complete line of IEC contactors and relays up through 800 amp and 500 HP. All products are available as open devices or as an enclosed AC starter package. See sections B and F for enclosed starters.

MINI-CONTACTORS; 6 & 9 amp

Description / Features.....	A2
Non-reversing AC, DC, 3 pole, 6 & 9 amp.....	A3
Reversing AC, DC, 3 pole, 6 & 9 amp.....	A4
Overload Relays & Control Relays.....	A5
Starters / Accessories.....	A6
Engineering Data.....	A7
Dimensions.....	A8
Wiring Diagrams.....	A34

STANDARD CONTACTORS; 9 amp through 700 amp

Description / Features.....	A9
Non-reversing AC, DC, 3 & 4 pole, 9 - 34 amp.....	A10
Overload Relays, Open Starters; 9 - 32 amp.....	A11
Non-reversing AC, DC, 3 & 4 pole, 50 - 105 amp.....	A12
Overload Relays, Open Starters; 50 - 105 amp.....	A13
Non-reversing AC, DC, 3 pole; 150 - 700 amp.....	A14
Overload Relay, Open Starters; 150 - 700 amp.....	A15
Reversing AC, DC, 3 pole; 9 - 32 amp.....	A16
Reversing AC, DC, 3 pole; 50 - 700 amp.....	A17
Control Relays.....	A18
IEC Accessories.....	A19 - A21
Horsepower Motor Ratings.....	A22
Kilowatt Motor Ratings.....	A23
Engineering Data.....	A24 - A27
Dimensions.....	A28 - A33
Wiring Diagrams.....	A34

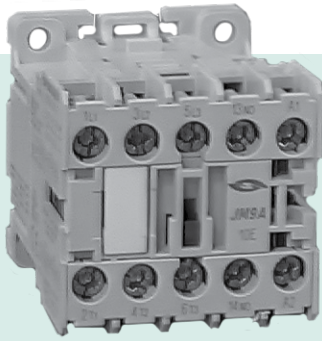

Low coil power consumption greatly expands application flexibility. Standard AC coils require only 1.4 watts and standard DC coils require 3 watts; this translates into low control power supply requirements and low heat losses inside the enclosure. Two special 24 volt PLC interface coil versions are also available to allow coils to be directly operated by PLC outputs.

Description

Mini Contactors – The JM family of mini-contactors and the JM family of control relays offer the user and equipment designer a compact, reliable and versatile solution to today's demanding requirement of high performance in a confined space. In such applications, PLC compatibility is playing an ever-increasing role.

Contactors and control relays are available in either AC- or DC-controlled forms, and offer application flexibility through a wide variety of modular accessories. These devices are CE marked and dual-rated for worldwide acceptance by complying with UL, cUL and IEC 947 standards. Contactors and control relays may be conveniently mounted using a 35mm DIN rail or by affixing with screws to a base plate.

Featuring a conveniently compact size, a mechanical life rated at 10 million operations, and an electrical life (AC-3) rated in excess of 1 million operations at rated current. The JM mini-contactor family is suitable for a wide variety of applications—including pumps, fans, door operators, hoists, conveyers, commercial laundry equipment, machine tools, food-mixing equipment, irrigation systems and other utilizations.

Overload Relays – The Class 10 overload relay features include loss of phase sensitivity, ambient temperature compensation, choice of automatic or manual reset, trip indication (tripped "0", operational "1"), trip test, separate stop (red), and reset (blue) buttons.

Installation and wiring is simplified; the contactor holding interlock terminal (14) is fed through the overload relay for additional wiring convenience and simplification.

Optional overload relay accessories include an addable snap-on normally open signaling contact and a separate mount base/terminal assembly for applications where in-line installation is not convenient. The separate mounting base is suitable for either screw or DIN rail mounting.

Features

Modular design – One of the most attractive features of this product family is its modularity. Various configurations can be created by combining the JM contactors and JM control relays with the wide selection of accessories.

Compact size – The contactor/relay mounting profile is approximately 1 3/4" X 1 7/8"

Long Life – The JM family of contactors and relays offers superior performance. Mechanical life is rated at 10,000,000 operations. Contactor motor ratings (AC-3) are in excess of 1,000,000 electrical operations.

Reliable Operation – These products are manufactured with the latest advancements in materials technology and designed to ensure long, dependable operation. (Coils are designed for protection against burnout during demanding brownout conditions.)

Flexible mounting – Mounting is not restricted for contactor and relay applications; contactors may be horizontal-, tabletop-, or ceiling-mounted. Mounting flexibility is provided by a dual mounting system using either 35mm DIN rail or two #8 screws in opposite diagonal corners. The DIN rail release is located at the top, providing easy access when configured as a starter. Accessories are easily assembled to the JM contactors and relays, saving time while affording maximum versatility.

Easy Installation – Captive universal slot screws are standard on all contactors, relays, overloads, and accessories allowing installation with flat, star and phillips screwdrivers. All terminals are in the open position for production line and installation efficiency. Accessories are designed for fast installation on either contactors or relays.

Safety Features – Finger and back-of-hand protection are provided. All screw and quick connect type terminals are clearly marked with dual markings where applicable, for easy identification and wiring convenience. UL and CSA approved.



NON-REVERSING MINI-CONTACTORS

A3

**Non-reversing AC, DC, 3 pole;
6 & 9 amp**

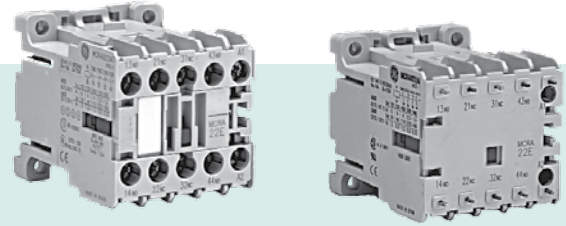

Open Type, Non-Reversing JM Contactor - (AC Coil)

Ampere Rating		Horsepower Rating				Terminal Type	Auxiliary Contact		Catalog No.	Price	
Ind. AC3	Res. AC1	1 Phase 115V 230V	3 Phase 200V 230V 460V 575V				N.O.	N.C.			
6	15	1/3 1	1 ½	1 ½	3	3	Screw	1 0	0 1	JM6A310AT- * JM6A301AT- *	\$62.00 \$62.00
							Printed Circuit	1 0	0 1	JM6A310AI- * JM6A301AI- *	\$69.00 \$69.00
9	20	½ 1 ½	3	3	5	5	Screw	1 0	0 1	JM9A310AT- * JM9A301AT- *	\$82.00 \$82.00
							Printed Circuit	1 0	0 1	JM9A310AI- * JM9A301AI- *	\$89.00 \$89.00

Open Type, Non-Reversing JM Contactor - (DC Coil)

Ampere Rating		Horsepower Rating				Terminal Type	Auxiliary Contact		Catalog No.	Price	
Ind. AC3	Res. AC1	1 Phase 115V 230V	3 Phase 200V 230V 460V 575V				N.O.	N.C.			
6	20	1/3 1	1 ½	1 ½	3	3	Screw	1 0	0 1	JM6C310AT- • JM6C301AT- •	\$85.00 \$85.00
							Printed Circuit	1 0	0 1	JM6C310AI- • JM6C301AI- •	\$92.00 \$92.00
9	20	½ 1 ½	3	3	5	5	Screw	1 0	0 1	JM9C310AT- • JM9C301AT- •	\$82.00 \$82.00
							Printed Circuit	1 0	0 1	JM9C310AI- • JM9C301AI- •	\$118.00 \$118.00

ORDERING INFORMATION

- Use complete catalog number. Replace the (*) with the suffix from the coil table.
- Accessories page A6
- Engineering Data page A7
- Dimension page A8

JM SERIES COIL TABLE

*AC Voltage	Suffix	*AC Voltage	Suffix	*DC Voltage	Suffix
24	C	240/277	N	12	B
120	J	480	W	24	D
208	M	600	Y	48	G
				120	K

Discount Schedule SC-70

Reversing AC, DC, 3 pole;
6 & 9 amp

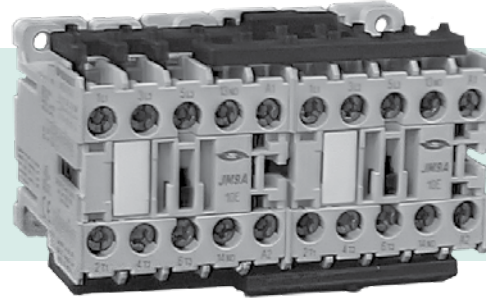

Open Type, Reversing JM Contactor - (AC Coil)

Ampere Rating		Horsepower Rating				Terminal Type	Auxiliary Contact		Catalog No.	Price		
Ind. AC3	Res. AC1	1 Phase 115V 230V		3 Phase 200V 230V 460V 575V			N.O.	N.C.				
6	15	1/3	1	1 1/2	1 1/2	3	3	Screw	0	1	RJM6A301AT- *	\$161.00
								Printed Circuit	0	1	RJM6A301AI- *	\$174.00
9	20	1/2	1 1/2	3	3	5	5	Screw	0	1	RJM9A301AT- *	\$200.00
								Printed Circuit	0	1	RJM9A301AI- *	\$213.00

Open Type, Reversing JM Contactor - (DC Coil)

Ampere Rating		Horsepower Rating				Terminal Type	Auxiliary Contact		Catalog No.	Price		
Ind. AC3	Res. AC1	1 Phase 115V 230V		3 Phase 200V 230V 460V 575V			N.O.	N.C.				
6	20	1/3	1	1 1/2	1 1/2	3	3	Screw	0	1	RJM6C301AT- •	\$207.00
								Printed Circuit	0	1	RJM6C301AI- •	\$220.00
9	20	1/2	1 1/2	3	3	5	5	Screw	0	1	RJM9C301AT- •	\$259.00
								Printed Circuit	0	1	RJM9C301AI- •	\$272.00

ORDERING INFORMATION

- Use complete catalog number. Replace the (*) with the suffix from the coil table.
- Accessories page A6
- Engineering Data page A7
- Dimension page A8

JM SERIES COIL TABLE

*AC Voltage	Suffix	*AC Voltage	Suffix	•DC Voltage	Suffix
24	C	240/277	N	12	B
120	J	480	W	24	D
208	M	600	Y	48	G
				120	K

Discount Schedule SC-70

Overload Relays

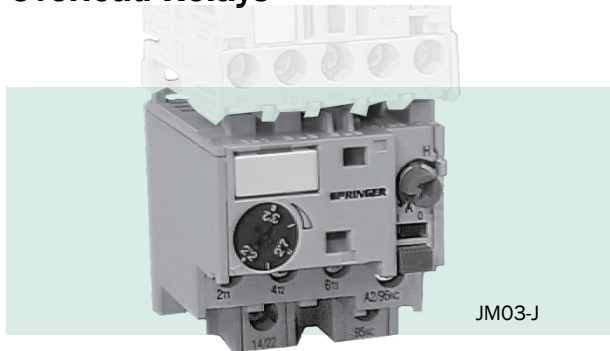

- Class 10A trip
- Ambient temperature compensation
- Differential phase loss sensitivity
- Trip indication
- Manual trip test
- Stop button (red)
- Reset button (blue), two positions: manual (H) and automatic (A)
- Pre-wired coil and NC contact connection
- Auxiliary contact feed-through wire, to facilitate installation
- Direct mounting or panel mount with base
- Separate panel mount use #MVE0T and #MVB0T (see accessories on page A6)

Catalog No.	Full Load Current Range		Starter Suffix	Price
	Min. A.	Max. A.		
JM03-A	0.11	0.17	A	\$66.00
JM03-B	0.17	0.26	B	\$66.00
JM03-C	0.26	0.43	C	\$66.00
JM03-D	0.43	0.65	D	\$66.00
JM03-E	0.65	1.0	E	\$66.00
JM03-F	0.85	1.3	F	\$66.00
JM03-G	1.1	1.6	G	\$66.00
JM03-H	1.35	2.0	H	\$66.00
JM03-I	1.7	2.4	I	\$66.00
JM03-J	2.2	3.2	J	\$66.00
JM03-R	2.5	4	R	\$66.00
JM03-K	3.0	4.7	K	\$66.00
JM03-L	4.0	6.3	L	\$66.00
JM03-M	5.5	8.0	M	\$66.00
JM03-N	7.5	10.5	N	\$66.00
JM03-P	10	14	P	\$66.00

Control Relays

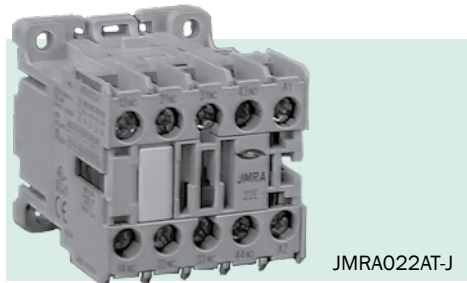

- Relays are suitable for use on alternating current (ac) control circuits up to 600 volts, and dc control circuits up to 240 volts.
- Control relays may be mounted on 35mm DIN rail EN50022-35, or may be panel-mounted using two or four #8 screws in diagonal corners.
- Screw and quick-connect terminals are protected against accidental contact in accordance with VDE0106T.100 and VBG4.
- Low-coil wattage requirement makes relay ideal for most applications. (24 Vdc PLC interface versions are available.)
- A wide range of accessories, including front-mounted auxiliary contact blocks, side-mounted auxiliary contact blocks, a timer, and surge suppressors, are easily installed on relays.

Control Relays - Type JMRA Ratings A600 & Q600

Contact Arrangement		Screw Terminals					
N.O.	N.C.	Catalog No	AC Coil	Price	Catalog No	DC Coil	Price
4	0	JMRA040AT-	*	\$69.00	JMRC040AT-	•	\$79.00
3	1	JMRA031AT-	*	\$69.00	JMRC031AT-	•	\$79.00
2	2	JMRA022AT-	*	\$69.00	JMRC022AT-	•	\$79.00
1	3	JMRA013AT-	*	\$69.00			
0	4	JMRA004AT-	*	\$69.00			

Relays may be built to provide up to 12 circuits by adding auxiliary contact blocks from page A6.

Discount Schedule SC-70

MINI-CONTACTOR - STARTERS & ACCESSORIES

JM Starters; 6amp, 9amp (Open starter = Contactor + Overload Relay)

Type JM Contactor (AC)

Horsepower Rating (Full Load Amps, 3 Phase)				Open Type Contactor	
200V	230V	460V	575V	Catalog No.	Price
1.5 (6A)	1.5 (5.2A)	3 (4.8A)	3 (3.9A)	JM6A310AT-*	\$62.00
3 (7.8A)	3 (9.6A)	5 (7.6A)	5 (6.1A)	JM9A310AT-*	\$82.00

+ Overload Relay - Type JM (Suffix Letter)

Catalog No.	Full Load Current Range		Starter Suffix	Price
	Min. A.	Max. A.		
JM03-A	0.11	0.17	A	\$66.00
JM03-B	0.17	0.26	B	\$66.00
JM03-C	0.26	0.43	C	\$66.00
JM03-D	0.43	0.65	D	\$66.00
JM03-E	0.65	1.0	E	\$66.00
JM03-F	0.85	1.3	F	\$66.00
JM03-G	1.1	1.6	G	\$66.00
JM03-H	1.35	2.0	H	\$66.00
JM03-I	1.7	2.4	I	\$66.00
JM03-J	2.2	3.2	J	\$66.00
JM03-R	2.5	4	R	\$66.00
JM03-K	3.0	4.7	K	\$66.00
JM03-L	4.0	6.3	L	\$66.00
JM03-M	5.5	8.0	M	\$66.00
JM03-N	7.5	10.5	N	\$66.00
JM03-P	10	14	P	\$66.00

Ordering Example: 5hp, 460V, 3 phase, 7.6 FLA

Part# JM9A310AT-WN \$148.00 List

(9amp mini-contactor, 460V coil, 7.5-10.5 overload, assembled)

*See coil table below

- See page A34 for wiring diagram

Accessories

Description	Contacts		Catalog No.	Price
	N.O.	N.C.		
Auxiliary Contact Blocks¹	Side Mount Screw Terminal	1 0	JMRL-110ATS JMRL-101ATS	\$12.00 \$12.00
	Side Mount Printed Circuit	1 0	JMRL-110AIS JMRL-101AIS	\$13.00 \$13.00
	Top Mount Two Pole Block	2 1	JMRN-220AT JMRN-211AT	\$16.00 \$16.00
	Top Mount Four Pole Block	4 2	JMRN-440AT JMRN-422AT	\$33.00 \$33.00
	Voltage Suppressor 12 - 60 Volt AC		MPOAAE1	\$27.00
	72-240 Volt AC		MPOAAE2	\$27.00
	Mechanical Interlock - For reversing contractor assemblies		MMH-0	\$10.00
	Coil Kits AC Coil Kits		MBOA-*	\$20.00
DC Coil Kits		MBOC-*	\$25.00	
Overload Relay - JM03 Series				
Line Terminal - For separate mounting		MVEOT	\$20.00	
DIN/Mounting Base - For separate mounting		MVBOT	\$7.00	
Auxiliary Contact Block - N.O.		JMTV10AT	\$13.00	
Reversing Jumpers		MVM01	\$27.00	

*COIL TABLE

AC Voltage	Suffix	AC Voltage	Suffix	DC Voltage	Suffix
24	C	240/277	N	12	B
120	J	480	W	24	D
208	M	600	Y	48	G
				120	K

Discount Schedule SC-70

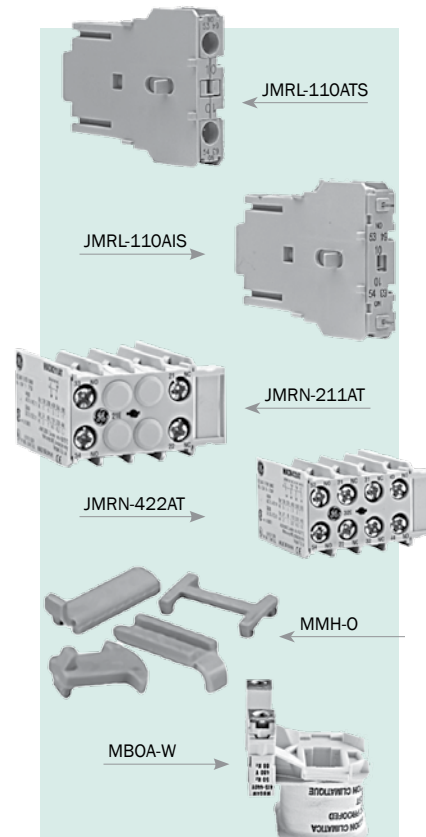

¹ Front mount auxiliary contacts may be combined with side mount auxiliary contacts for a total maximum number of six added auxiliary contacts.

Engineering Data; JM Series

		JM6	JM9
Rated insulation voltage (Ui) (acc. IEC947-4)	(V)	750	750
Rated thermal current (Ith) q < 60½ C (1)	(A)	20	20
Frequency limits	(Hz)	0...400	0...400
Making capacity (r.m.s.) Ue < 690V 50/60Hz	(A)	160	160
Breaking capacity (r.m.s.) Ue < 440V	(A)	106	106
Ue = 500V	(A)	90	90
Ue = 690V	(A)	80	80
Short-time current			
0.3 sec,	(A)	470	470
1.0 sec,	(A)	250	250
5.0 sec,	(A)	125	125
10.0 sec,	(A)	95	95
30.0 sec,	(A)	70	70
1.0 min,	(A)	50	50
3.0 min,	(A)	40	40
Recovery time	(min.)	10	10
Protection against short-circuits (IEC 947-4) Coordination type "2"			
aM/gl	(A)	10/16	12/20
Without welding contacts	aM/gl (A)	8/12	10/16
Circuit-breaker rating (characteristics G CEE 19.1)		16	20
Impedance per pole	(MΩ)	1.76	1.59
Power dissipation per pole			
AC1	(W)	0.7	0.6
AC3	(W)	0.06	0.128
Insulation resistance			
Between adjacent poles	(MΩ)	>10	>10
Between pole and earth	(MΩ)	>10	>10
Between input and output	(MΩ)	>10	>10
Guaranteed no overlap between NO and NC contacts			
Space	(mm)	1	1
Time	(ms)	>2	>2

Terminal Capacity

Terminal with M 3.5 screw (with pozidrive head and safety flange)		Tightening torque 0.8Nm - 7Lb-1n
Solid wire	Ømm	0.75 to 2 x 2 w
Flexible wire without terminal	mm²	0.75 to 2.5 x 2 w
Flexible wire with terminal with cap	mm²	0.75 to 2.5 x 1 w
Faston terminal 2.8 2 insulated terminals	mm²	0.75 to 1 x 2 w
Terminal for printed circuit (O of PCB hole)		1 x 2 wires
Terminal for printed circuit (O of PCB hole)		1.8 mm
Ring terminal cap		7.8 mm
Fork terminal cap		6.5 mm

(1) Insulated terminal type B 2.8 x 0.8 with wire 1 mm² Ie = 8A acc, to DIN 46247

Electrical Endurance

Category AC1

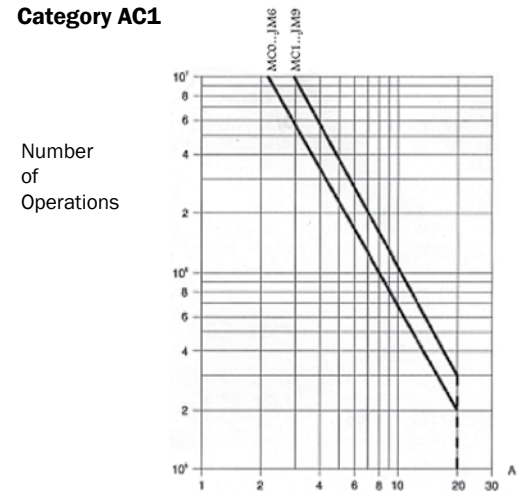

Category AC3

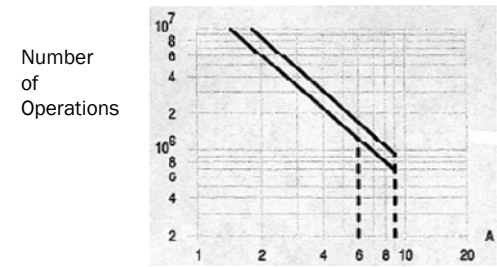

Category AC4

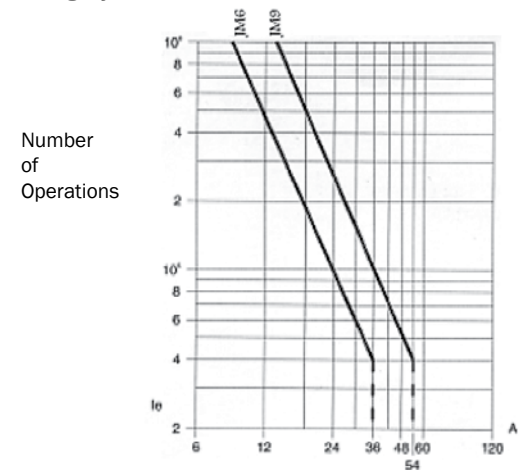

Discount Schedule SC-70

Contactors & Relays - Types JM & JMRA

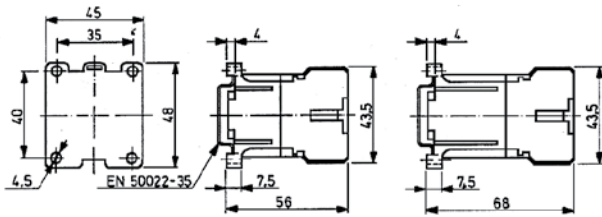

4 Mounting Holes for #8 Screws

Type	Dimensions - Approximate Inches and (Millimeters)						Coil VA	
	A	B	C	D	E	F	Sealed	Inrush
JM6A JM9A JMRA	1.77 (45)	1.89 (48)	2.20 (56)	1.38 (35)	1.57 (40)	.39 (9.8)	4.9VA	34.2VA
JM6C JM9C JMRC	1.77 (45)	1.89 (48)	2.68 (68)	1.38 (35)	1.57 (40)	.39 (9.8)	3W	3W

Reversing Contactors & Relays - Type JM

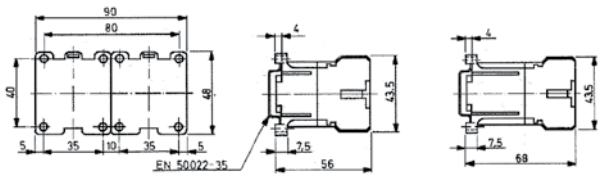

4 Mounting Holes for #8 Screws

Type	Dimensions - Approximate Inches and (Millimeters)							Coil VA	
	A	B	C	D	E	F	G	Sealed	Inrush
JM6A JM9A	3.54 (90)	.39 (10)	2.2 (56)	1.38 (35)	1.89 (48)	1.57 (40)	1.77 (45)	4.9VA	34.2VA

Starters - Type JM

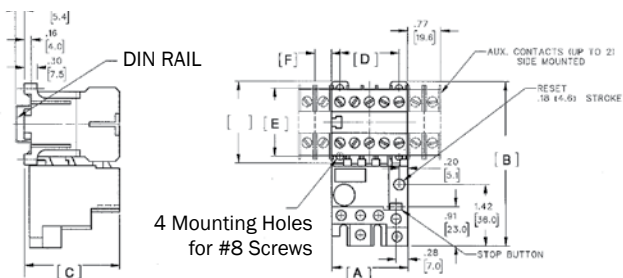

4 Mounting Holes for #8 Screws

Type	Dimensions - Approximate Inches and (Millimeters)						Coil VA	
	A	B	C	D	E	F	Sealed	Inrush
JM6A JM9A	1.77 (45)	3.9 (99)	2.20 (56)	1.38 (35)	1.57 (40)	.39 (9.8)	4.9VA	34.2VA

Standard IEC Contactors; 9amp through 700amp

Description

Contactors are most commonly used to switch motor loads in applications where running over current protection is either not required or is provided separately. Contactors consist of a magnetically actuated switch which can be remotely operated by a push button station or pilot device such as a proximity switch, limit switch, auxiliary contacts, etc.

Standard contactor components are loaded with features that make them easy to install, allow more flexible configurations, lower inventory requirements, and make better use of panel space — and their performance is second to none.

Features

- Power circuit (AC): up to 690v
- UL listed and CSA certified
- Screws protected against accidental contact in accordance with VOE 0106.
- Full compliment of accessories; overload relays, auxiliary top and side mount contacts, mechanical interlocks, electronic timer blocks, pneumatic timer blocks, pole terminated protection.
- AC coils (both 50 Hz and 60 Hz versions) and DC coils are available for a wide range of voltages for flexibility.



JC12A310T-J



JC50A311M-S

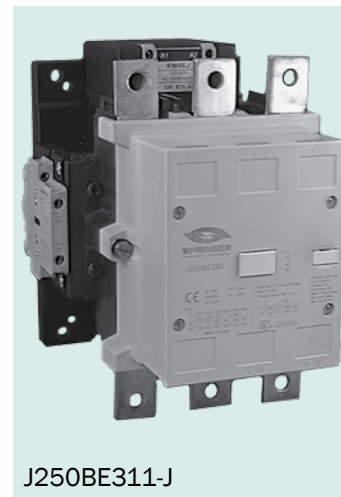

J250BE311-J

Sizing of Contactors

- See pages A22 & A23 for either Horsepower or Kilowatt Motor Ratings
- Amp rating in AC3 (Inductive load) and AC1 (resistive load)

NON-REVERSING CONTACTORS; 9 amp - 32 amp

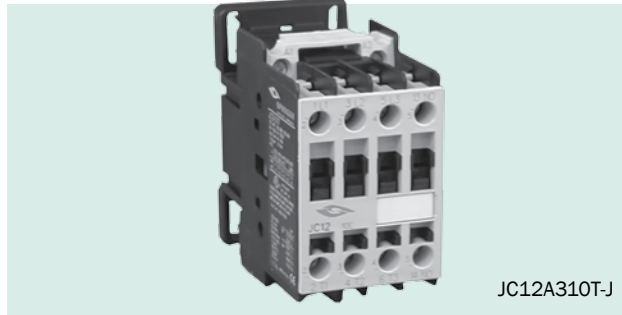

Non-Reversing Open Type JC Contactors - (AC Coil) 3 & 4 pole, 9amp - 32 amp

Amp Rating		Horsepower Rating						Power Poles		Auxiliary Contact		Catalog No.	Price
Ind.	Res.	1 Phase		3 Phase				N.O.	N.C.	N.O.	N.C.		
AC3	AC1	115V	230V	200V	230V	460V	575V	N.O.	N.C.	N.O.	N.C.		
9	25	0.75	1.5	3	3	5	7.5	3	0	1	0	JC09A310T-*	\$141.00
								3	0	0	1	JC09A301T-*	\$141.00
12	25	0.75	2	3	3	7.5	10	3	0	1	0	JC12A310T-*	\$176.00
								3	0	0	1	JC12A301T-*	\$176.00
								4	0	0	0	JC12A400T-*	\$176.00
18	32	1	3	5	5	10	15	3	0	1	0	JC18A310T-*	\$203.00
								3	0	0	1	JC18A301T-*	\$203.00
								4	0	0	0	JC18A400T-*	\$203.00
25	45	2	3	7.5	7.5	15	20	3	0	1	0	JC25A310M-*	\$226.00
								3	0	0	1	JC25A301M-*	\$226.00
								4	0	0	0	JC25A400M-*	\$289.00
32	60	2	5	10	10	20	25	3	0	1	0	JC32A310M-*	\$258.00
								3	0	0	1	JC32A301M-*	\$258.00
								4	0	0	0	JC32A400M-*	\$369.00

Notes: Consult factory for 4 pole (2 N.O. / 2 N.C.) units. Dimensions located on page A28.

Non-Reversing Open Type JC Contactors - (DC Coil) 3 pole, 9amp - 32 amp

Amp Rating		Horsepower Rating						Power Poles		Auxiliary Contact		Catalog No.	Price
Ind.	Res.	1 Phase		3 Phase				N.O.	N.C.	N.O.	N.C.		
AC3	AC1	115V	230V	200V	230V	460V	575V	N.O.	N.C.	N.O.	N.C.		
9	25	0.5	1.5	3	3	5	7.5	3	0	1	0	JC09D310T-•	\$179.00
12	25	0.75	2	3	3	7.5	10	3	0	1	0	JC12D310T-•	\$218.00
18	32	1	3	5	5	10	15	3	0	1	0	JC18D310T-•	\$241.00
25	45	2	3	7.5	7.5	15	20	3	0	1	0	JC25D310M-•	\$272.00
32	54	2	5	10	10	20	25	3	0	1	0	JC32D310M-•	\$320.00

Notes: Consult factory for 4 pole (4 N.O.) units. Dimensions located on page A29.

ORDERING INFORMATION

- Use complete catalog number. Replace the (*) with the suffix from the coil table.
- Accessories pages A19 - A21
- Engineering Data pages A24 - A27
- Dimensions pages A28 - A33

COIL TABLE

* AC Voltage	Suffix	* AC Voltage	Suffix	• DC Voltage	Suffix
24 (50-60Hz)	1	230 (50Hz)	N	12	B
120 (50-60Hz)	J	415 (50Hz)	W	24	D
208 (60Hz)	L	480 (60Hz)	U	48	G
240 (60Hz)	S	380 (50Hz)	U	125	K
277 (60Hz)	N	600 (60Hz)	Y	250	T

Discount Schedule SC-70

JL1 OVERLOAD RELAYS & OPEN STARTERS

Overload Relays; Type JL1 (.16 - 40amp range)

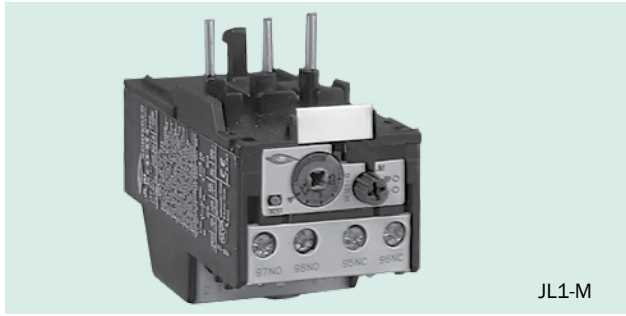

JL1 overload relays provide motor overload protection through fixed bimetal heaters. These relays are ambient compensated and utilize a differential mechanism for single phase sensitivity. The trip setting is adjustable for the range listed.

Overload relays may be set for 4 different operational modes – manual reset only, automatic reset only, manual reset/stop or automatic reset/stop. Stop is initiated by pushing the reset button which interrupts the holding circuit in the latter two listed modes (see page A27).

Overload relays feature visible trip indication, reset on the upstroke, weld check, and trip test.

Consult factory for electronic solid state relays.

* Separate, stand-alone overhead relays available by adding part #JLXP (Accessories page A21.)

Overload Relay - Type JL

Catalog No.	Full Load Current Range		Starter Suffix	Price
	Min. A.	Max. A.		
JL1B	0.16	0.26	B	\$90.00
JL1C	0.25	0.41	C	\$90.00
JL1D	0.4	0.65	D	\$90.00
JL1F	0.65	1.1	F	\$90.00
JL1G	1	1.5	G	\$90.00
JL1H	1.3	1.9	H	\$90.00
JL1J	1.8	2.7	J	\$90.00
JL1K	2.5	4	K	\$90.00
JL1L	4	6.3	L	\$93.00
JL1M	5.5	8.5	M	\$93.00
JL1N	8	12	N	\$93.00
JL1P	10	16	P	\$93.00
JL1S	14.5	18	S	\$93.00
JL1T	17.5	22	T	\$93.00
JL1U	21	26	U	\$93.00
JL1V	25	32	V	\$107.00
JL1W	30	40	W	\$128.00

JC Series Open Starters; 9 - 32amp

Starter consists of Type JC Contactor (AC) +

Horsepower Rating (Full Load Amps) 3 Phase				Open Type Contactor	
200V	230V	460V	575V	Catalog No.	Price
3 (7.8)	3 (6.2)	5 (7.6)	7.5 (9)	JC09A310T- *	\$141.00
3 (11)	3 (9.6)	7.5 (11)	10 (11)	JC12A310T- *	\$176.00
5 (62)	5 (68)	10 (65)	15 (62)	JC18A310T- *	\$203.00
7.5 (22)	7.5 (22)	15 (21)	20 (27)	JC25A310M- *	\$226.00
10 (32.2)	10 (28)	21 (27)	25 (27)	JC32A310M- *	\$258.00

Notes: Dimensions located on page A29.

COIL TABLE

AC Voltage	Suffix	AC Voltage	Suffix
24 (50-60Hz)	1	230 (50Hz)	N
120 (50-60Hz)	J	415 (50Hz)	W
208 (60Hz)	L	480 (60Hz)	U
240 (60Hz)	S	380 (50Hz)	U
277 (60Hz)	N	600 (60Hz)	Y

ORDERING EXAMPLE

10hp, 230V, 3 phase, 28.0 FLA
Part # JC32A310M-SV..... List \$365.00
(32amp contactor, 230V coil, 25-32 amp overload, assembled)

Overload Relay - Type JL1

Catalog No.	Full Load Current Range		Starter Suffix	Price
	Min. A.	Max. A.		
JL1B	0.16	0.26	B	\$90.00
JL1C	0.25	0.41	C	\$90.00
JL1D	0.4	0.65	D	\$90.00
JL1F	0.65	1.1	F	\$90.00
JL1G	1	1.5	G	\$90.00
JL1H	1.3	1.9	H	\$90.00
JL1J	1.8	2.7	J	\$90.00
JL1K	2.5	4	K	\$90.00
JL1L	4	6.3	L	\$93.00
JL1M	5.5	8.5	M	\$93.00
JL1N	8	12	N	\$93.00
JL1P	10	16	P	\$93.00
JL1S	14.5	18	S	\$93.00
JL1T	17.5	22	T	\$93.00
JL1U	21	26	U	\$93.00
JL1V	25	32	V	\$107.00
JL1W	30	40	W	\$128.00

Discount Schedule SC-70

Non-Reversing Open Type JC Contactors - (AC Coil) 3 pole & 4 pole , 50amp - 105 amp

Amp Rating		Horsepower Rating						Power Poles		Auxiliary Contact		Catalog No.	Price
Ind.	Res.	1 Phase		3 Phase				N.O.	N.C.	N.O.	N.C.		
AC3	AC1	115V	230V	200V	230V	460V	575V	N.O.	N.C.	N.O.	N.C.		
50	90	5	7.5	15	15	40	40	3	0	1	1	JC50A311M-*	\$328.00
65	110	5	10	20	20	50	50	3 4	0 0	1 0	1 0	JC65A311M- * JC65A400M- *	\$394.00 \$458.00
80	110	7.5	15	20	25	50	60	3	0	1	1	JC80A311M- *	\$484.00
95	140	7.5	15	25	30	60	60	3 4	0 0	1 0	1 0	JC95A311M- * JC95A400M- *	\$546.00 \$779.00
105	140	10	20	30	40	75	75	3	0	1	1	JCC5A311M- *	\$779.00

Notes: Four power poles consisting of 2 N.O./2 N.C. are available upon request. Consult factory for part number and pricing. Dimensions located on page A28

Non-Reversing Open Type JC Contactors - (AC/DC Electronic Coil) 3 pole, 50amp - 105amp

Amp Rating		Horsepower Rating						Power Poles		Auxiliary Contact		Catalog No.	Consult Factory for Price
Ind.	Res.	1 Phase		3 Phase				N.O.	N.C.	N.O.	N.C.		
AC3	AC1	115V	230V	200V	230V	460V	575V	N.O.	N.C.	N.O.	N.C.		
50	90	5	7.5	15	15	40	40	3	0	0	0	JC50E300M-•	\$448.00
65	110	5	10	20	20	50	50	3	0	0	0	JC65E300M-•	\$486.00
80	110	7.5	15	20	25	50	60	3	0	0	0	JC80E300M-•	\$554.00
95	140	7.5	15	25	30	60	60	3	0	0	0	JC95E300M-•	\$628.00
105	140	10	20	30	40	75	75	3	0	0	0	JCC5E300M-	\$879.00

Notes: Four power poles consisting of 4 N.O. or 2 N.O./2 N.C. are available upon request. Consult factory for part number and pricing.

*** AC COIL TABLE**

AC Voltage	Suffix	60Hz Voltage	Suffix
24 (50-60Hz)	1	277 (60Hz)	N
120 (50-60Hz)	J	230 (50Hz)	N
208 (60Hz)	L	415 (50Hz)	W
240 (60Hz)	S	480 (60Hz)	U

• AC/DC COIL TABLE

Voltage	Suffix
24-28	D
42-48	F
110-125	J
220-250	N
440-500	Y

Discount Schedule SC-70

JL2 Series Overload Relays

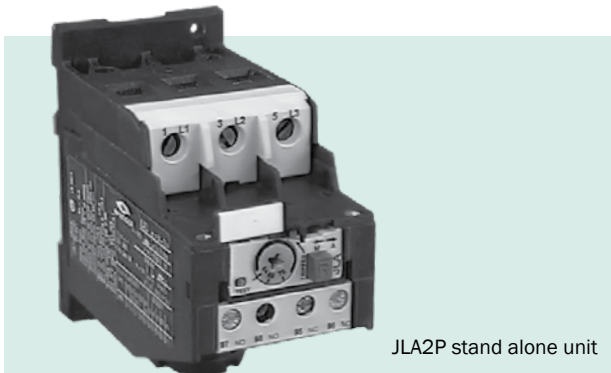

Overload Relay - Type JL2

Catalog No.	Full Load Current Range		Starter Suffix	Price
	Min. A.	Max. A.		
JL2A	11.5	15	A	\$161.00
JL2B	14.5	19	B	\$161.00
JL2C	18.5	25	C	\$161.00
JL2D	24	32	D	\$161.00
JL2E	30	43	E	\$161.00
JL2G	42	55	G	\$161.00
JL2H	54	65	H	\$161.00
JL2J	64	82	J	\$192.00
JL2L	78	97	L	\$235.00
JL2M	90	110	M	\$235.00

Separate Mounted Overload Relay

Type of Mounting	Rated Current (Amps)		Catalog No.	Price
	Min. A.	Max. A.		
Separate or Back-Panel Mount	11.5	15	JLA2PA	\$229.00
	14.5	19	JLA2PB	\$229.00
	18.5	25	JLA2PC	\$229.00
	24	32	JLA2PD	\$229.00
	30	43	JLA2PE	\$229.00
	42	55	JLA2PG	\$229.00
	54	65	JLA2PH	\$229.00
	64	82	JLA2PJ	\$274.00
	78	97	JLA2PL	\$317.00
	90	110	JLA2PM	\$317.00

JC Series Open Starters; 50 amp - 105 amp

Starter consists of Type JC Contactor

Horsepower Rating				Open Type Contactor	
200V	230V	460V	575V	Catalog No.	Price
15	15	40	40	JC50A311M- *	\$328.00
20	20	50	50	JC65A311M- *	\$394.00
20	25	50	60	JC80A311M- *	\$484.00
25	30	60	60	JC95A311M- *	\$546.00
30	40	75	75	JCC5A311M- *	\$779.00

Notes: Dimensions are located on page A30.

***AC COIL TABLE**

AC Voltage	Suffix	AC Voltage	Suffix
24 (50 60Hz)	1	230 (50Hz)	N
120 (50 60Hz)	J	415 (50Hz)	W
208 (60Hz)	L	480 (60Hz)	U
240 (60Hz)	S	380 (50Hz)	U
277 (60Hz)	N	600 (60Hz)	Y

+ Overload Relay - Type JL2

Catalog No.	Full Load Current Range		Starter Suffix	Price
	Min. A.	Max. A.		
JL2A	11.5	15	A	\$161.00
JL2B	14.5	19	B	\$161.00
JL2C	18.5	25	C	\$161.00
JL2D	24	32	D	\$161.00
JL2E	30	43	E	\$161.00
JL2G	42	55	G	\$161.00
JL2H	54	65	H	\$161.00
JL2J	64	82	J	\$192.00
JL2L	78	97	L	\$235.00
JL2M	90	110	M	\$235.00

ORDERING EXAMPLE

20hp, 230V, 3 phase, 54.0 FLA
Part # JC65A311M-SH..... List \$555.00
(65amp contactor, 230V coil, 54-65 amp overload, assembled)

Discount Schedule SC-70

NON-REVERSING CONTACTORS; 150 amp - 700 amp

Non-reversing Open Type JC Contactors - 3 pole, AC & DC 150 amp - 700 amp

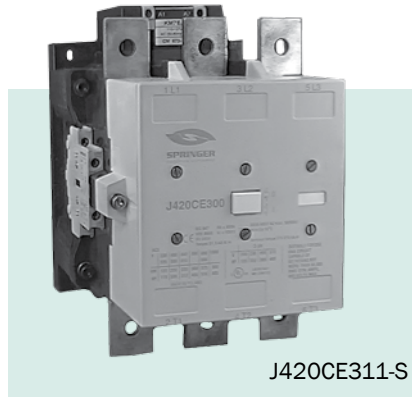
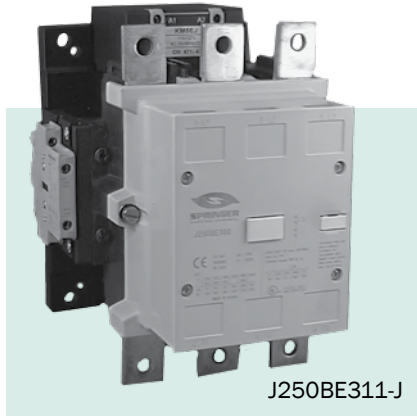

Amp Rating		Horsepower Rating (Full Load Amps)				Control Circuit	Auxiliary Contact		Catalog No.	Price
Ind. AC3	Res. AC1	200V	3 Phase			3 Pole	N.O.	N.C.		
			230V	460V	575V					
150	250	50	50 (130)	125 (156)	125 (125)	AC AC/DC	1 1	1 1	J150CA311 * J150CE311 •	\$1,189.00 \$1,312.00
185	250	50	60 (154)	150 (180)	150 (144)	AC AC/DC	1 1	1 1	J185CA311 * J185CE311 •	\$1,550.00 \$1,673.00
250	315	60	75 (192)	150 (180)	150 (144)	AC/DC	1	1	J250BE311 •	\$2,173.00
309	450	100	100 (248)	250 (302)	300 (289)	AC/DC	1	1	J309BE311 •	\$2,952.00
420	600	125	150 (360)	300 (361)	400 (382)	AC/DC	1	1	J420CE311 •	\$4,428.00
550	700	150	200 (480)	400 (477)	500 (472)	AC/DC	1	1	J550CE311 •	\$6,888.00
700	1,000	200	250	500 (590)	600	AC/DC	1	1	J700BE311 •	\$9,348.00

Notes: Dimensions located on page A30, A31

* AC COIL TABLE

AC Voltage	Suffix	60Hz Voltage	Suffix
24 (50 60Hz)	1	277 (60Hz)	N
120 (50 60Hz)	J	480 (60Hz)	U
208 (60Hz)	L		
240 (60Hz)	S		

* AC/DC COIL TABLE

Voltage	Suffix
24V-28V	D
110V-127V	J
220V-250V	N
440V-500V	Y

Discount Schedule SC-70

Overload-Relays; Types JL3, JL4, JL5

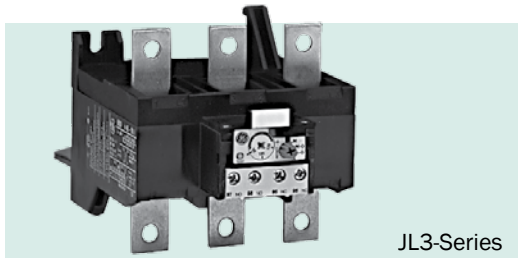

JL-3 Overload Relay

For Use With	Type of Mounting	Rated Current (Amps)		Catalog No.	Starter Suffix	Price
		Min.	Max.			
J150 or J185	Direct or Separate Mount	55	80	JL3B	B	\$303.00
		63	90	JL3C	C	\$303.00
		90	120	JL3D	D	\$303.00
		110	140	JL3E	E	\$369.00
		140	190	JL3F	F	\$369.00

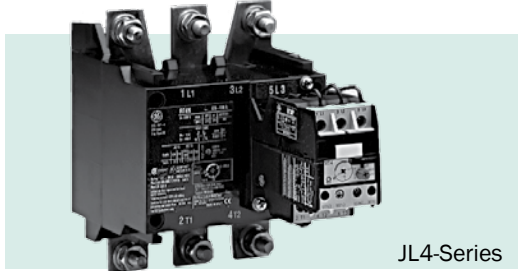

JL-4 Overload Relay

For Use With	Type of Mounting	Rated Current (Amps)		Catalog No.	Starter Suffix	Price
		Min.	Max.			
J250 or J309	Separate Mount	120	190	JL4N	N	\$467.00
		175	280	JL4P	P	\$467.00
		200	310	JL4R	R	\$623.00

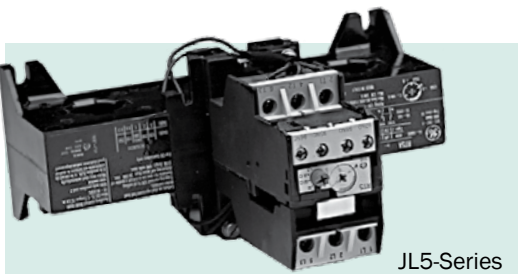

JL-5 Overload Relay

For Use With	Type of Mounting	Rated Current (Amps)		Catalog No.	Starter Suffix	Price
		Min.	Max.			
J420 or J550 or J700	Separate Mount	120	190	JL5A	A	\$1,051.00
		175	280	JL5B	B	\$1,051.00
		250	400	JL5C	C	\$1,051.00
		315	500	JL5D	D	\$1,481.00
		430	700	JL5E	E	\$1,481.00

JC Series Open Starters; 150amp - 700amp

Open Type, JC Contactor - (AC/DC Coil) + Overload Relay

Ind. AC3 Rating	Horsepower Rating (Full Load Amps)				Open Type Contactor Catalog No.	Price	Overload Relay
	200V	230V	460V	575V			
150	50	50 (130)	125 (156)	125 (125)	J150CE311 *	\$1,312.00	+ JL3 Series Overload (see above starter suffix)
185	50	60 (154)	150 (180)	150 (144)	J185CE311 *	\$1,673.00	
250	60	75 (192)	150 (180)	150 (144)	J250BE311 •	\$2,173.00	+ JL4 Series Overload (see above starter suffix)
309	100	100 (248)	250 (302)	300 (289)	J309BE311 •	\$2,952.00	
420	125	150 (360)	300 (361)	400 (382)	J420CE311 •	\$4,428.00	+ JL5 Series Overload (see above starter suffix)
550	150	200 (480)	400 (477)	500 (473)	J550CE311 •	\$6,888.00	
700	200	250	500 (590)	600	J700BE311 •	\$9,348.00	

Ordering Example

250hp , 460V, 3 phase = Catalog # J309BE311-YR.....List \$3,575.00
(309amp contactor, 460V Coil, 200-310 overload, assembled)

Discount Schedule SC-70

REVERSING CONTACTORS; 9 amp - 32 amp



Reversing Open Type JC Contactors - (AC Coil) 3 pole, 9 amp - 32 amp

Amp Rating		Horsepower Rating						Power Poles		Auxiliary Contact		Catalog No.	Price
Ind.	Res.	1 Phase		3 Phase				N.O.	N.C.	N.O.	N.C.		
AC3	AC1	115V	230V	200V	230V	460V	575V	N.O.	N.C.	N.O.	N.C.		
9	25	0.75	1.5	3	3	5	7.5	3	0	1	0	RJC09A310T-*	\$362.00
12	25	0.75	2	3	3	7.5	10	3	0	1	0	RJC12A310T-*	\$432.00
18	32	1	3	5	5	10	15	3	0	1	0	RJC18A310T-*	\$486.00
25	45	2	3	7.5	7.5	15	20	3	0	1	0	RJC25A310M-*	\$558.00
32	60	2	5	10	10	20	25	3	0	1	0	RJC32A310M-*	\$622.00

Notes: All reversers come standard with a mechanical interlock that consists of 2 normally closed auxiliaries along with the unit pre-wired for "reversing" application. To add overload relay see page A11.

Reversing Open Type JC Contactors - (DC Coil) 3 pole, 9amp - 32amp

Amp Rating		Horsepower Rating						Power Poles		Auxiliary Contact		Catalog No.	Price
Ind.	Res.	1 Phase		3 Phase				N.O.	N.C.	N.O.	N.C.		
AC3	AC1	115V	230V	200V	230V	460V	575V	N.O.	N.C.	N.O.	N.C.		
9	25	0.5	1.5	3	3	5	7.5	3	0	1	0	RJC09D310T-•	\$438.00
12	25	0.75	2	3	3	7.5	10	3	0	1	0	RJC12D310T-•	\$516.00
18	32	1	3	5	5	10	15	3	0	1	0	RJC18D310T-•	\$562.00
25	45	2	3	7.5	7.5	15	20	3	0	1	0	RJC25D310T-•	\$650.00
32	54	2	5	10	10	20	25	3	0	1	0	RJC32D310M-•	\$746.00

Notes: All reversers come standard with a mechanical interlock that consists of 2 normally closed auxiliaries along with the unit pre-wired for "reversing" application. To add overload relay see page A11.

* AC COIL TABLE

AC Voltage	Suffix	AC Voltage	Suffix	AC Voltage	Suffix
24 (50-60Hz)	1	277 (60Hz)	N	380 (50Hz)	U
120 (50-60Hz)	J	230 (50Hz)	N	600 (60Hz)	Y
208 (60Hz)	L	415 (50Hz)	W		
240 (60Hz)	S	480 (60Hz)	U		

• DC COIL TABLE

DC Voltage	Suffix
12	B
24	D
48	G
125	K
250	T

Discount Schedule SC-70

Reversing Open Type JC Contactors - (AC, AC/DC Coil) 3 pole, 50 amp - 700 amp



RJC65A311M-S

Amp Rating		Horsepower Rating				Power Poles		Auxiliary Contact		Catalog No.	Price
Ind.	Res.	3 Phase				N.O.	N.C.	N.O.	N.C.		
AC3	AC1	200V	230V	460V	575V						
50	90	15	15	40	40	3	0	1	1	RJC50A311M *	\$788.00
65	110	20	20	50	50	3	0	1	1	RJC65A311M *	\$920.00
80	110	20	25	50	60	3	0	1	1	RJC80A311M *	\$1,100.00
95	140	20	30	60	60	3	0	1	1	RJC95A311M *	\$1,224.00
105	140	30	40	75	75	3	0	1	1	RJCC5A311M *	\$1,690.00
150	250	50	50	125	125	3	0	1	1	RJ150CA311M *	\$2,585.00
185	250	50	60	150	150	3	0	1	1	RJ185CA311M *	\$3,307.00
250	315	60	75	150	150	3	0	1	1	RJC250BE311M-•	\$4,553.00
309	500	100	100	250	300	3	0	1	1	RJ309BE311M-•	\$6,111.00
420	600	125	150	300	400	3	0	1	1	RJ420CE311M-•	\$9,063.00
550	700	150	200	400	500	3	0	1	1	RJ550BE311M •	\$13,983.00
700	1000	200	250	500	600	3	0	1	1	RJ700BE311M-•	\$18,903.00

Notes: All reversers come standard with a mechanical interlock that consists of 2 normally closed auxiliaries along with the unit pre-wired for "reversing" application. To add overload relay see page A13.

*** AC COIL TABLE**

AC Voltage	Suffix	60Hz Voltage	Suffix
24 (50-60Hz)	1	277 (60Hz)	N
120 (50-60Hz)	J	480 (60Hz)	U
208 (60Hz)	L		
240 (60Hz)	S		

• AC/DC COIL TABLE

Voltage	Suffix
24V-28V	D
110V-127V	J
220V-250V	N
440V-500V	Y

Discount Schedule SC-70

Control Relays

- AC voltage up to 690V, DC voltage up to 440V
- Fixed or din-rail mountable
- Full line of accessories available
- Nomenclature;

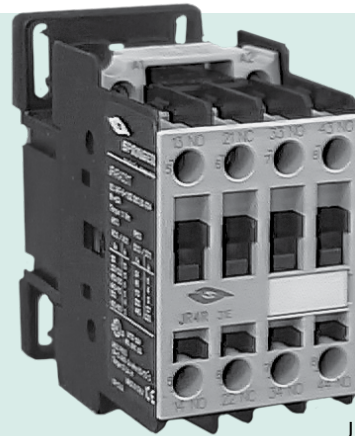
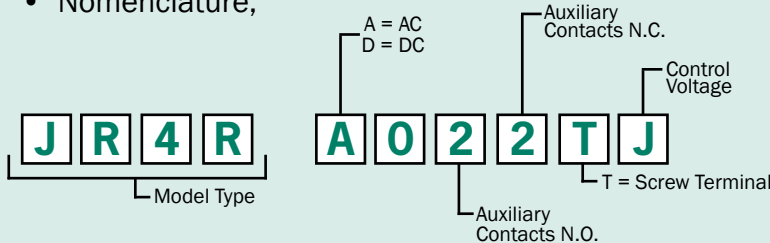

JR4RA031T-J

I.E. Control Relay; AC, 2 Normally Open & 2 Normally Closed Contacts, Screw Terminals, 120V Coil

Control Relay - Type JR4R (Ratings A600 & P600)



JR4RA040T-J

Contact Arrangement		AC Coil		DC Coil	
N.O.	N.C.	Catalog No.	Price	Catalog No.	Price
4	0	JR4RA040T *	\$94.00	JR4RD040T •	\$164.00
3	1	JR4RA031T *	\$94.00	JR4RD031T •	\$164.00
2	2	JR4RA022T *	\$94.00	JR4RD022T •	\$164.00
0	4	JR4RA004T *	\$94.00	JR4RD004T •	\$164.00

Relay may be built to provide up to 12 circuits by adding auxiliary contact blocks from page A20

Contact Ratings

NEMA Rating Design	Max. Volts	Amperes			Voltamperes	
		Make	Break	Continuous	Make	Break
Maximum AC Contact Rating Per Pole, 50 or 60 Herz						
A600	120	60	6	10	7200	720
	240	30	3	10	7200	720
	480	15	1.5	10	7200	720
	600	12	1.2	10	7200	720
Maximum DC Contact Rating Per Pole, 50 or 60 Herz						
Q600	125	.55	.55	2.5	69	69
	250	.27	.27	2.5	69	69
	600	.1	.1	2.5	-	-
P600	125	1.1	1.1	5	138	138
	250	.55	.55	5	138	138
	600	.2	.2	5	-	-

ORDERING INFORMATION

- Accessories page A20
- Dimensions page A28

* AC COIL TABLE

• DC COIL

* AC Voltage	Suffix	* AC Voltage	Suffix	• DC Voltage	Suffix
24	1	277	N	24	D
120	J	480	U	48	G
208	L	600	Y	125	K
240	S			250	T

Discount Schedule SC-70

Accessories; Coils

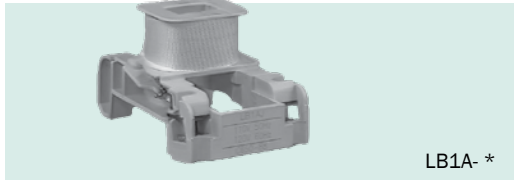

AC & DC Coils for JC Contactors

For Use With	Coil Frequency	Catalog No.	Price
JC09 JC12 JC18 JC22	AC	LB1A- *	\$39.00
JC25 JC32 JC34	AC	LB3A- *	\$54.00
JC50 JC65 JC80 JC95 JCC5	AC	LB4A- *	\$62.00
JC09 JC12 JC18 JC22	DC	LB1D- •	\$59.00
JC25 JC32 JC34	DC	LB3D- •	\$82.00

AC Coils for Standard Type J Contactors

For Use With	Coil Frequency	Catalog No.	Price
J150CA J185CA	AC	C12168- *	\$118.00
J150BA	AC	C04255- *	\$118.00
J185BA	AC	C04787- *	\$118.00

AC/DC Electronic Coils; J150CE - J700BE

For Use With	Coil Frequency	Coil No.	Price	Module No.	Price
J150CE J185CE	AC/DC	KB4E- •	\$164.00	KM4E- •	\$295.00
J250BE J309BE	AC/DC	KB5E- •	\$205.00	KM5E- •	\$336.00
J420CE J550CE J700BE	AC/DC	KB7E- •	\$304.00	KM7E- •	\$369.00

Notes: Both **Coil No.** and **Module No.** must be used together

* AC COIL TABLE

Voltage	Suffix	Voltage	Suffix
24 (50-60Hz)	1	230 (50Hz)	N
120 (50-60Hz)	J	415 (50Hz)	W
208 (60Hz)	L	480 (60Hz)	U
240 (60Hz)	S	380 (50Hz)	U
277 (60Hz)	N	600 (60Hz)	Y

• DC COIL TABLE

DC Voltage	Suffix
12	B
24	D
48	G
125	K
250	T

• AC & DC ELECTRONIC COIL TABLE

Voltage	Suffix
24V - 28V	D
110V - 127V	J
220V - 250V	N
440V - 500V	Y

Discount Schedule SC-70



Front-Mount Auxiliary Contact Block*

Description	Contacts		Catalog No	Price
	N.O.	N.C.		
For Use	1	0	JCAF10	\$18.00
With- All	0	1	JCAF01	\$18.00
JC Contactors	Overlapping	1	JCAF10G	\$25.00
JC09-JCC5		0	JCAF01G	\$25.00



Side-Mount Auxiliary Contact Block*

Description		Contacts		Catalog No	Price
		N.O.	N.C.		
For Use	Base Block	1	1	JCAL11	\$31.00
With- All		2	0	JCAL20	\$31.00
JC Contactors	Adder Block	1	1	JRAL11	\$31.00
JC09-J700		2	0	JRAL20	\$31.00

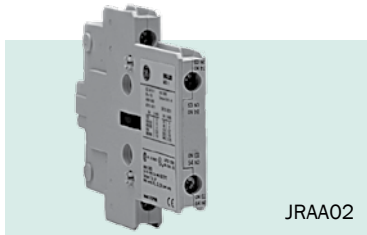

Mechanical Interlocks

Contactor Size	Contacts	Catalog No	Price
For Use With - JC09, JC12, JC18, JC22, JC25, JC32, JC34, JC50, JC65, JC80, JC95, JCC5	Without built-in contacts	JRAA	\$41.00
	With 2 built-in N.C. contacts	JRAA02	\$57.00
J150-J700	Horizontal	BEKHJ	\$107.00
J150-J309	Vertical	BEKVSJ	\$295.00
J420-J700	Vertical	BEKVAJ	\$328.00

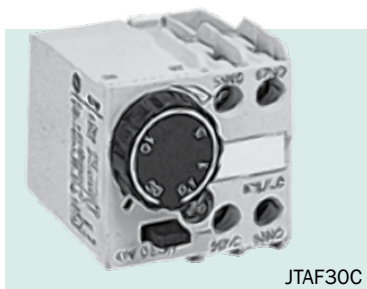

Pneumatic Timers

Description	Time Delay	Time Range	Contacts		Catalog No.	Price
			N.O.	N.C.		
For use with JC Contactors JC09-JCC5. (5-75 HP, 460V)	On	1 - 30 Sec.	1	1	JTAF30C	\$144.00
		10-60 Sec.	1	1	JTAF60C	\$144.00
	Off	1 - 30 Sec.	1	1	JTAF30D	\$144.00
		10-60 Sec.	1	1	JTAF60D	\$144.00

ORDERING INFORMATION

* MAXIMUM # OF AUXILIARY CONTACT BLOCKS PER EACH CONTACTOR

For Use With	Maximum Numbers of Aux. Contact Blocks	Arrangement of Aux. Contact Blocks
5-15 Hp contactors; JC09 JC12, JC18	4	4 Front-Mount, or 1 Side-Mount on each side
20-25 Hp contactors; JC25, JC32, JC34	6	4 Front-Mount plus 1 Side-Mount, or 2 Front-Mount plus 1 Side-Mount on each side
30-75 Hp contactors; JC50, JC65, JC80, JC95, JCC5	8	6 Front-Mount plus 1 side Mount, or 2 Side-Mount on each side

Discount Schedule SC-70

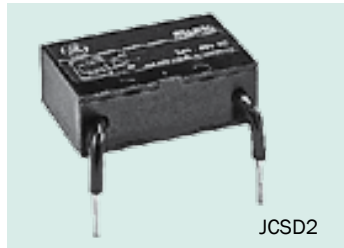

Surge Suppressor

Surge Suppressor Type		Horsepower	Voltage	Catalog No.	Price
RC	For Use With- JC09, JC12, JC18, JC22, JC32, JC34 contactors	5-25 hp AC	24-48 VAC	JCSR2G	\$39.00
			50-127 VAC	JCSR2K	\$39.00
			130-240 VAC	JCSR2R	\$39.00
RC	For Use With- JC50, JC65, JC80, JC95, JCC5 contactors	30-75 hp AC	24-48 VAC	JCSR3G	\$39.00
			50-127 VAC	JCSR3K	\$39.00
			130-240 VAC	JCSR3R	\$39.00
DIODE	For Use With- All JC contactors	5-25 hp DC	12-600 VDC	JCSD2	\$39.00
VARISTOR	For Use With- All JC contactors	50-75 hp AC/DC	24 - 48 V,AC-DC	JCSV3G	\$39.00
			50 - 127 V,AC-DC	JCSV3K	\$39.00
			130-250 V,AC-DC	JCSV3R	\$39.00
			380-500 V,AC-DC	JCSV3U	\$52.00

Misc. Accessories

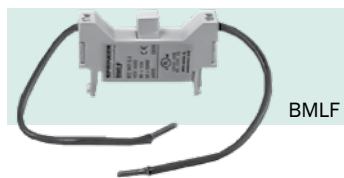
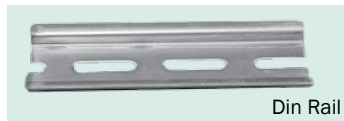

Description	Catalog No.	Price
Overload Base - Separate Mounting	JL1 Series JLXP	\$34.00
	JL2 Series JL2XP	\$68.00
DIN Rail 6 ft. Length	DINRAIL	\$30.00
Start Contact Block (JC09 - JC34 Starters)	BMLF	\$16.00

Contact Kits type JC & J

Main Contact Kit - Includes 3 Sets of Contacts and Springs for:	Catalog No.	Price	Main Contact Kit - Includes 3 Sets of Contacts and Springs for:	Catalog No.	Price
JC50A311M	V31206B	\$110.00	J150CA311	V31175CA	\$397.00
JC65A311M	V31207B	\$131.00	J185CA311	V31108CA	\$623.00
JC80A311M	V31208B	\$161.00	J250BE311	V31109BA	\$738.00
JC95A311M	V31209B	\$182.00	J309BE311	V31195BA	\$1,017.00
JCC5A311M	V31210B	\$262.00	J420CE311	V31110CE	\$1,476.00
			J550CE311	V31111CE	\$2,132.00
			J700BE311	V31112BA	\$3,157.00

Discount Schedule SC-70

Full-Load Motor-Running Currents in Amperes Corresponding to Various A.C. Horsepower Motor Ratings

The table below provides the average full-load currents of squirrel cage motors in accordance with IEC conventions. These are given only as a guide. Refer to the actual motor nameplate for full-load current values

H.P.	110V - 120V		220V - 240V		380V - 415V		440V - 480V		550V - 600V		2.3 KV	4.16 KV
	Single Phase	Three Phase	Single Phase	Three Phase	Single Phase	Three Phase	Single Phase	Three Phase	Single Phase	Three Phase	Three Phase	Three Phase
1/10	3.0	---	1.5	---	---	---	---	---	---	---	---	---
1/8	3.8	---	1.9	---	---	---	---	---	---	---	---	---
1/6	4.4	---	2.2	---	1.4	---	---	---	---	---	---	---
1/4	5.8	---	2.9	---	1.85	---	---	---	---	---	---	---
1/3	7.2	---	3.6	---	2.32	---	---	---	---	---	---	---
1/2	9.8	4.4	4.9	2.2	3.19	1.28	2.5	1.1	2.0	0.9	---	---
3/4	13.8	6.4	6.9	3.2	4.47	1.78	3.5	1.6	2.8	1.3	---	---
1	16.0	8.4	8.0	4.2	5.12	2.30	4.0	2.1	3.2	1.7	---	---
1.5	20.0	12.0	10.0	6.0	6.38	3.32	5.0	3.0	4.0	2.4	---	---
2	24.0	13.6	12.0	6.8	7.66	4.34	6.0	3.4	4.8	2.7	---	---
3	34.0	19.2	17.0	9.6	10.87	6.14	8.5	4.8	6.8	3.9	---	---
5	56.0	30.4	28.0	15.2	17.90	9.71	14.0	7.6	11.2	6.1	---	---
7.5	80.0	44.0	40.0	22.0	26.80	14.00	21.0	11.0	16.0	9.0	---	---
10	100.0	56.0	50.0	28.0	33.2	17.90	26.0	14.0	20.0	11.0	---	---
15	135.0	84.0	68.0	42.0	---	26.80	34.0	21.0	27.0	17.0	---	---
20	---	108.0	88.0	54.0	---	34.50	44.0	27.0	35.0	22.0	---	---
25	---	136.0	110.0	68.0	---	43.50	55.0	34.0	44.0	27.0	---	---
30	---	160.0	136.0	80.0	---	51.20	68.0	40.0	54.0	32.0	---	---
40	---	208.0	176.0	104.0	---	66.50	88.0	52.0	70.0	41.0	---	---
50	---	260.0	216.0	130.0	---	83.10	108.0	65.0	86.0	52.0	---	---
60	---	---	---	154.0	---	103.0	---	77.0	---	62.0	16.	9.
75	---	---	---	192.0	---	128.0	---	96.0	---	77.0	20.	11.
100	---	---	---	248.0	---	165.0	---	124.0	---	99.0	26.	14.3
125	---	---	---	312.0	---	208.0	---	156.0	---	125.0	31.	17.
150	---	---	---	360.0	---	240.0	---	180.0	---	144.0	37.	20.
200	---	---	---	480.0	---	320.0	---	240.0	---	192.0	49.	27.
250	---	---	---	602.0	---	403.0	---	302.0	---	242.0	60.	33.
300	---	---	---	---	---	482.0	---	361.0	---	289.0	72.	40.
350	---	---	---	---	---	560.0	---	414.0	---	336.0	83.	46.
400	---	---	---	---	---	636.0	---	477.0	---	382.0	95.	52.
500	---	---	---	---	---	786.0	---	590.0	---	472.0	118.	65.

Notes:

1. To obtain F.L.C. for 200 and 208 volt motors multiply 230 volts values by 1.15 and 1.10 respectively.
2. To obtain F.L.C. for 265 and 277 volt motors multiply 230 volts values by .87 and .83 respectively.

Kilowatt Motor Ratings

The table below provides the average full-load currents of squirrel cage motors in accordance with IEC conventions. These are given only as a guide. Refer to the actual motor nameplate for full-load current values

Power Kilowatts	Single-Phase Motor		Three-Phase Motor					
	120V	240V	230V	400V	415V	440V	500V	690V
	A	A	A	A	A	A	A	A
0.37	3.9	3.6	2	.98	--	0.99	1	--
0.55	5.2	4.8	2.8	1.5	--	1.36	1.21	--
0.75	6.6	6.1	3.6	1.9	2	1.68	1.5	--
1.1	9.6	8.8	5.2	2.5	2.5	2.37	2	--
1.5	12.7	11.7	6.8	3.4	3.5	3.06	2.6	--
1.8	15.7	14.4	--	--	--	--	--	--
2.2	18.6	17.1	9.6	4.8	5	4.42	3.8	--
3	24.3	22.2	--	6.3	6.5	5.77	5	3.5
3.7	--	--	15.2	--	--	--	--	--
4	29.6	27.1	--	8.1	8.4	7.9	6.5	4.9
4.4	34.7	31.8	--	--	--	--	--	--
5.2	39.8	36.5	--	--	--	--	--	--
5.5	42.2	38.7	22	11	11	10.4	9	6.7
6	44.5	40.8	--	--	--	--	--	--
7	49.5	45.4	--	--	--	--	--	--
7.5	54.4	50	28	14.8	14	13.7	12	9
9	--	--	--	18.1	17	16.9	13.9	10.5
11	--	--	42	21	21	20.1	18.4	12.1
15	--	--	54	28.5	28	26.5	23	16.5
18.5	--	--	68	35	35	32.8	28.5	20.2
22	--	--	80	42	40	39	33	24.2
30	--	--	104	57	55	51.5	45	33
37	--	--	130	69	66	64.0	55	40
45	--	--	154	81	80	76	65	46.8
55	--	--	192	100	100	90	80	58
75	--	--	248	131	135	125	105	75.7
90	--	--	312	162	165	146	129	94
110	--	--	360	195	200	178	156	113
132	--	--	--	233	240	215	187	135
--	--	--	480	222	260	236	207	--
160	--	--	--	285	280	256	220	165
--	--	--	600	--	--	--	--	--
200	--	--	--	352	340	321	281	203
220	--	--	720	388	385	353	310	224
250	--	--	840	437	425	401	360	253
280	--	--	--	--	--	--	--	--
315	--	--	--	555	535	505	445	321
--	--	--	1080	--	--	--	--	--
355	--	--	--	605	580	549	500	350
--	--	--	1200	--	--	--	--	--
400	--	--	--	675	650	611	540	390
450	--	--	1440	--	--	--	--	--
500	--	--	--	855	820	780	680	494
560	--	--	--	950	920	870	760	549
630	--	--	--	1045	1020	965	850	605
710	--	--	--	1200	1140	1075	960	694
800	--	--	--	--	1320	1250	1100	790
900	--	--	--	--	1470	1390	1220	880

Power Circuit JC09 - JCC5 Series

Three-pole version													
		JC09	JC12	JC18	JC22	JC25	JC32	JC34	JC50	JC65	JC80	JC95	JCC5
Rated thermal current I _{th} at q < 55½ C	(A)	25	25	32	45	45	60	60	90	110	110	140	140
Rated operational current I _e	(A)	9	12	18	22	25	32	34	50	65	80	95	105
Rated operational voltage U _e	(V)	690	690	690	690	690	690	690	690	690	690	690	690
Four-pole version (4 N.O., 2 N.O. + 2 N.C.)													
Rated thermal current I _{th} at q < 55½ C	(A)		25	32		45	60			110	110	140	
Rated operational current I _e	(V)		690	690		690	690			690	690	690	
			(1) 2 NO + 2 NC only										
			(2) 4 NO only										
Three-Pole and Four-Pole Version													
Rated insulation voltage U _i	(V)	1000	1000	1000	1000	1000	1000	1000	1000	1000	1000	1000	1000
Maximum continuous current AC1	(A)	25	25	32	45	45	60	60	90	110	110	140	140
Frequency limits (Hz)		25...400	25...400	25...400	25...400	25...400	25...400	25...400	25...400	25...400	25...400	25...400	25...400
Making capacity (RMS) (acc. IEC 947)	(A)	450	450	450	450	550	550	550	1000	1000	1000	1280	1280
Breaking capacity (RMS) (acc. IEC 947)													
U _e < 400V	(A)	250	250	250	350	450	450	450	920	920	920	1050	1050
U _e = 500V	(A)	250	250	250	320	450	450	450	920	920	920	1050	1050
U _e = 690V	(A)	130	130	130	170	205	205	205	780	780	780	950	950
Short-time current													
1 sec.	(A)	455	455	570	630	1010	1010	1265	1580	2530	2530	3300	3300
5 sec.	(A)	205	205	254	280	450	450	450	710	1130	1130	1485	1485
10 sec.	(A)	144	144	180	200	320	320	400	500	800	800	1050	1050
30 sec.	(A)	85	85	104	115	185	185	230	290	460	460	600	600
1 min.	(A)	60	60	74	80	130	130	165	205	325	325	430	430
3 min.	(A)	35	35	45	50	90	90	100	120	185	185	250	250
Recovery time	(min.)	10	10	10	10	10	10	10	10	10	10	10	10
Protection against short-circuit with fuses													
Coordination type "2"													
aM	(A)	10	12	20	25	25	35	40	50	80	80	125	160
gL-gG	(A)	25	35	35	50	63	63	63	100	160	160	200	200
Without welding													
aM	(A)	8	8	16	20	20	20	25	40	50	50	80	80
gL-gG	(A)	10	10	25	35	35	35	50	80	100	100	160	160
Impedance per pole	mΩ	2.35	2.35	2.41	1.65	1.28	1.28	0.95	0.85	0.86	0.86	0.76	0.76
Power dissipation per pole													
AC1	(W)	1.47	1.47	2.46	3.34	2.59	4.6	3.42	6.89	10.4	10.4	14.89	14.89
AC3	(W)	0.19	0.34	0.78	1.03	0.80	1.31	1.52	2.12	3.63	5.5	6.86	8.37
Insulation resistance													
Between adjacent poles	mΩ	>10	>10	>10	>10	>10	>10	>10	>10	>10	>10	>10	>10
Between poles and earth	mΩ	>10	>10	>10	>10	>10	>10	>10	>10	>10	>10	>10	>10
Between input and output	mΩ	>10	>10	>10	>10	>10	>10	>10	>10	>10	>10	>10	>10

Power Circuit J150 - J825 Series

Three-pole contactors		J150	J185	J250	J309	J420	J550	J700	J825
Rated thermal current I _{th} at q <40½ C	(A)	250	250	315	450	600	700	1000	1250
Rated operational current I _e AC3	(A)	150	185	250	309	420	550	700	825
Rated operational voltage U _e	(V)	1000	1000	1000	1000	1000	1000	1000	1000
Raged insulation voltage U _i	(V)	1000	1000	1000	1000	1000	1000	1000	1000
Maximum continuous current AC1	(A)	250	250	315	450	600	700	1000	1250
Frequency limits	(Hz)	25...400	25...400	25...400	25...400	25...400	25...400	25...400	25...400
Breaking capacity (RMS)									
U _e < 400V	(A)	1600	1600	3500	3500	5600	5600	7300	6600
U _e = 500V	(A)	1600	1600	3500	3500	5600	5600	7300	6600
U _e = 690V	(A)	100	100	2200	2200	3500	3500	6700	6000
U _e = 1000V	(A)	350	350	1100	1100	2000	2000	3500	3500
Short-time current									
1 sec.	(A)	2500	2500	5500	5500	7500	7500	9700	11600
5 sec.	(A)	2500	2500	3500	3500	5200	5200	7700	8800
10 sec.	(A)	2300	2300	2500	2500	4000	4000	6100	7350
30 sec.	(A)	1250	1250	1600	1600	2800	2800	4400	5300
1 min.	(A)	900	900	1200	1200	1800	1800	3500	4500
3 min.	(A)	600	600	900	900	1200	1200	2300	2800
Recovery time	(min.)	10	10	10	10	10	10	10	10
Short-circuit protection with fuses									
Coordination type "2"									
aM	(A)	160	200	250	315	400	500	630	1000
gL-gG	(A)	250	250	400	500	630	800	1000	1250
Impedance per pole	(mΩ)	0.30	0.30	0.28	0.28	0.15	0.13	0.14	0.11
Power dissipation per pole									
AC1	(W)	19	19	27.7	56.7	54.3	63.7	140	171.8
AC3	(W)	6.8	10.3	17.5	26.7	26.5	45.3	68.6	74.8
Insulation resistance									
Between adjacent poles	(mΩ)	>10	>10	>10	>10	>10	>10	>10	>10
Between poles and earth	(mΩ)	>10	>10	>10	>10	>10	>10	>10	>10
Between input and output	(mΩ)	>10	>10	>10	>10	>10	>10	>10	>10
Four-pole contactors		J185	J250	J309	J420	J550	J700	J825	
Rated thermal current I _{th} at q <40½ C	(A)	325	400	500	600	700	1000	1250	
Rated operational voltage U _e	(V)	1000	1000	1000	1000	1000	1000	1000	
Raged insulation voltage U _i	(V)	1000	1000	1000	1000	1000	1000	1000	
Maximum continuous current AC1	(A)	325	400	500	600	700	100	1250	
Frequency limits	(Hz)	25...400	25...400	25...400	25...400	25...400	25...400	25...400	
Making capacity (RMS)	(A)	1850	2500	3700	6500	6500	6700	8250	
Breaking capacity (RMS)									
U _e < 400V	(A)	1600	3500	3500	5600	5600	6700	6600	
U _e = 500V	(A)	1600	3500	3500	5600	5600	6700	6600	
U _e = 690V	(A)	1000	2200	2200	5000	5000	6000	6000	
U _e = 1000V	(A)	350	1100	1100	300	300	3500	3500	
Short-time current									
1 sec.	(A)	2500	5500	5500	7500	7500	9700	11600	
5 sec.	(A)	2500	3500	3500	5200	5200	7700	8800	
10 sec.	(A)	2300	2500	2500	4000	4000	6100	7350	
30 sec.	(A)	1250	1600	1600	2800	2800	4400	5300	
1 min.	(A)	900	1200	1200	1800	1800	3500	4500	
3 min.	(A)	600	900	800	1200	1200	2300	2800	
Recovery time	(min.)	10	10	10	10	10	10	10	
Short-circuit protection with fuses									
Coordination type "2"									
gL-gG	(A)	400	500	500	6300	800	1000	1250	
Impedance per pole	(mΩ)	0.32	0.28	0.28	0.15	0.13	0.14	0.11	
Power dissipation per pole									
AC1	(W)	33.8	44.8	56.7	61.2	68.6	140	171.8	
Insulation resistance									
Between adjacent poles	(mΩ)	>10	>10	>10	>10	>10	>10	>10	>10
Between poles and earth	(mΩ)	>10	>10	>10	>10	>10	>10	>10	>10
Between input and output	(mΩ)	>10	>10	>10	>10	>10	>10	>10	>10

Life Curves - AC Contactors; JC09 - J875

AC-1: Non-inductive, or lightly inductive loads, e.g., resistance furnaces

ELECTRICAL ENDURANCE

Operation

RATED CURRENT I_e
For all voltages

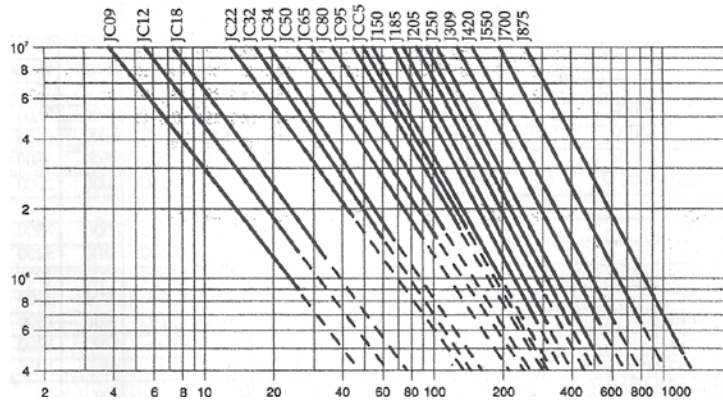

AC-3: Interruption of Running Squirrel - Cage Motors

ELECTRICAL ENDURANCE

Operation

RATED CURRENT I_e
($U_e \leq 440V$)

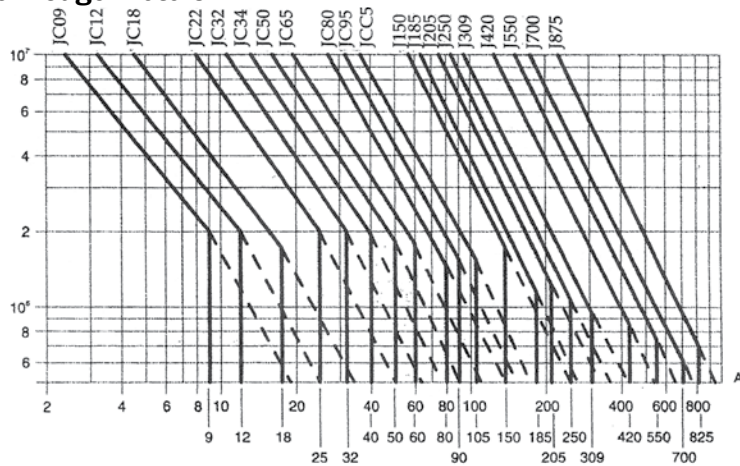

AC-4: Inching (Jogging) of Squirrel - Cage Motors

ELECTRICAL ENDURANCE

Operation

RATED CURRENT I_e
($U_e \leq 440V$)

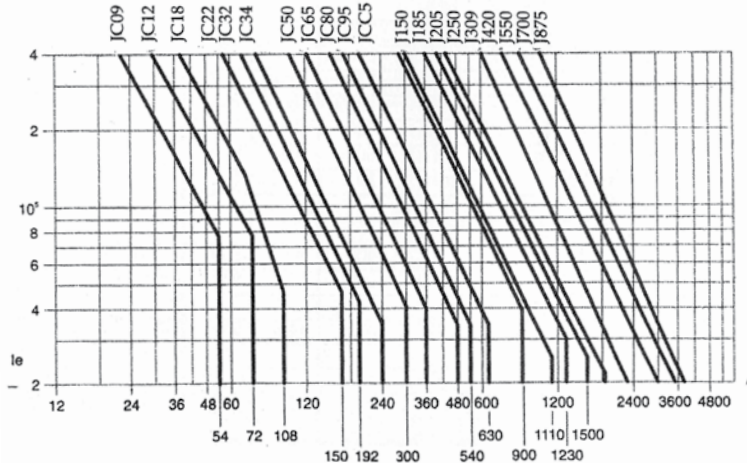

IEC Overload Relays

**Tripping Curves
JL1 Class 10A**

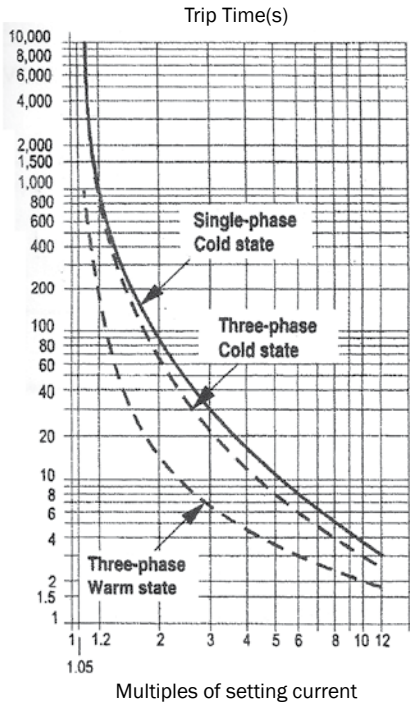

JL2 Class 10A

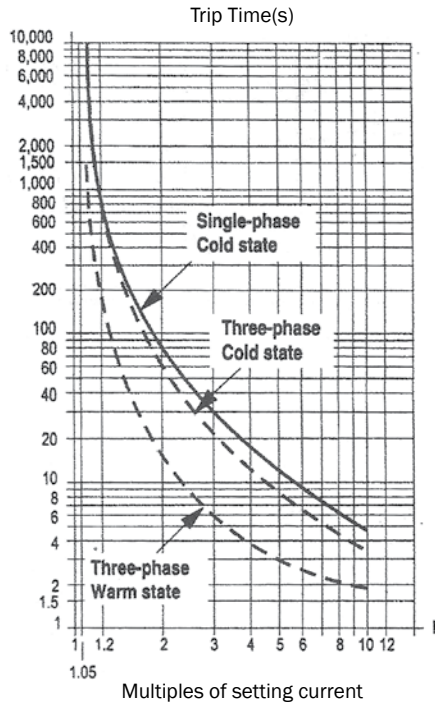

JL3 Class 10A

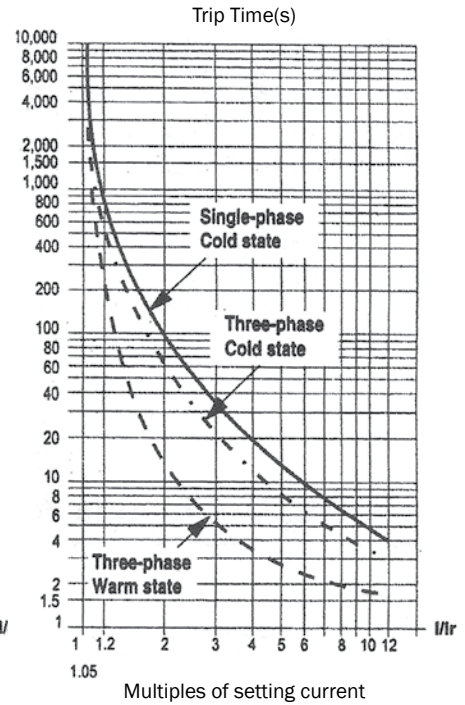

Functions of the reset-button

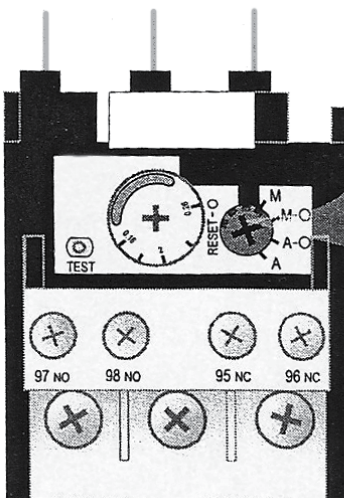

* Recommended setting

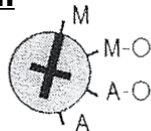

Manual RESET

(Operator must manually reset O/L relay when tripped)

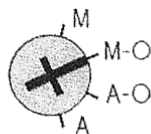

***Manual RESET and STOP**

(Operator must manually reset O/L relay when tripped. STOP can also be initiated by pushing the reset button which interrupts the holding circuit)

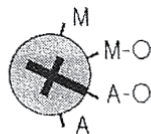

Automatic RESET and STOP

(After tripping, O/L relay will automatically turn on when proper temperature is met. STOP can also be initiated by pushing the reset button which interrupts the holding circuit.)

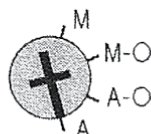

Automatic RESET no STOP

(After tripping, O/L relay will automatically turn on when proper temperature is met.)

Contactors & Relays - Types JC & JR4R / JC09 - JC18

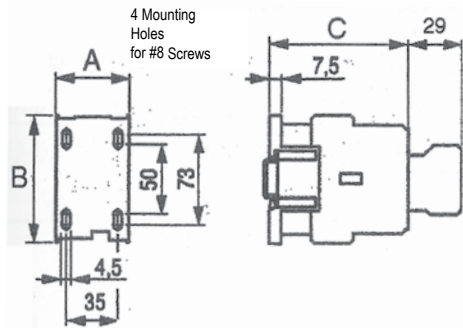

Type	Dimensions - Approximate Inches and (Millimeters)							Coil VA	
	A	B	C	D	E	F	G	Sealed	Inrush
JC09A JC12A JC18A JR4R	1.77 (45)	3.1 (81)	3.34 (85)	1.38 (35)	2.8 (73)	1.97 (50)	.18 (4.5)	6VA	45VA

Contactors - Type JC / JC25 - JC34

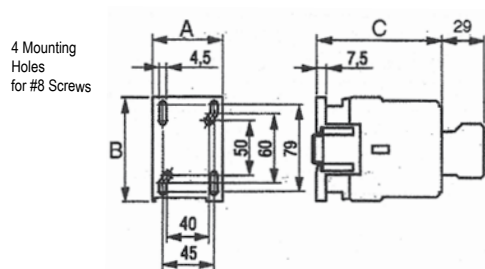

Type	Dimensions - Approximate Inches and (Millimeters)							Coil VA	
	A	B	C	D	E	F	G	Sealed	Inrush
JC25A JC32A JC34A	2.17 (55)	3.43 (87)	3.86 (98)	1.77 (45)	3.11 (79)	1.97 (50)	.18 (4.5)	9VA	88VA

Contactors - Type JC / JC50 - JC80

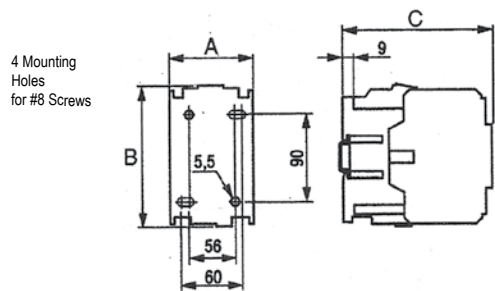

Type	Dimensions - Approximate Inches and (Millimeters)							Coil VA	
	A	B	C	D	E	F	G	Sealed	Inrush
JC50A JC65A JC80A	2.6 (66)	4.6 (117.5)	4.57 (116)	3.54 (90)	2.38 (60)	2.2 (56)	.22 (5.5)	15.5VA	191VA

Contactors - Type JC / JC95 - JCC5

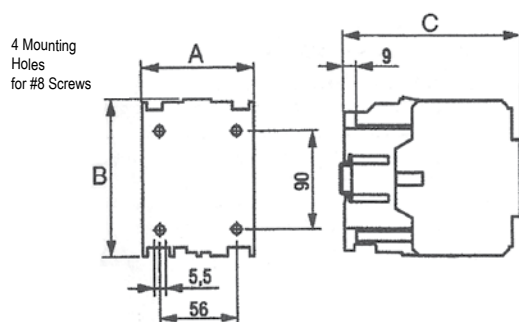

Type	Dimensions - Approximate Inches and (Millimeters)						Coil VA	
	A	B	C	D	E	F	Sealed	Inrush
JC95A JCC5A	2.95 (75)	4.63 (117.5)	4.96 (126)	3.54 (90)	2.2 (56)	.22 (5.5)	15.5VA	191VA

Contactors - Types JC (DC) / JC09D - JC18D

4 Mounting Holes for #8 Screws

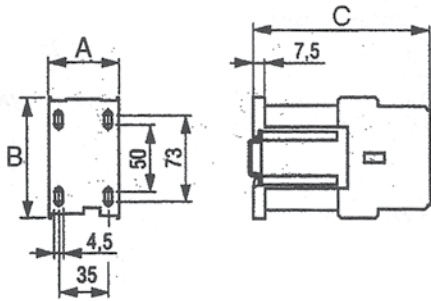

Type	Dimensions - Approximate Inches and (Millimeters)							Coil	VA
	A	B	C	D	E	F	G	Sealed	Inrush
JC09D	1.77	3.1	4.53	1.38	2.8	1.97	.18	5.5W	5.5W
JC12D	(45)	(81)	(115)	(35)	(73)	(50)	(4.5)		
JC18D									

Contactors - Types JC (DC) / JC25D - JC34D

4 Mounting Holes for #8 Screws

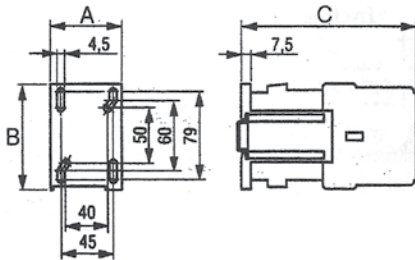

Type	Dimensions - Approximate Inches and (Millimeters)							Coil	VA
	A	B	C	D	E	F	G	Sealed	Inrush
JC25D	2.17	3.43	5.26	1.77	3.11	1.97	.18	7.5W	7.5W
JC32D	(55)	(87)	(134)	(45)	(79)	(50)	(4.5)		
JC34D									

Open Starters - Types JC / JC09 - JC18

4 Mounting Holes for #8 Screws

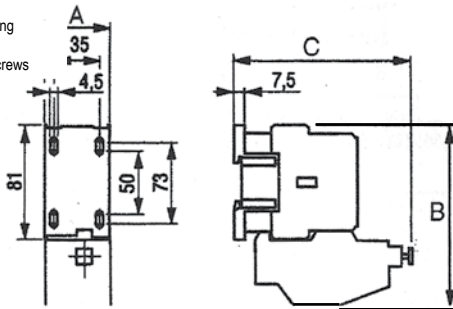

Type	Dimensions - Approximate Inches and (Millimeters)							Coil	VA
	A	B	C	D	E	F	G	Sealed	Inrush
JC09	1.77	5.03	4.3	1.38	2.72	1.97	.18	6VA	45VA
JC12	(45)	(128)	(108)	(35)	(70)	(50)	(4.5)		
JC18									

Open Starters - Types JC / JC25 - JC34

4 Mounting Holes for #8 Screws

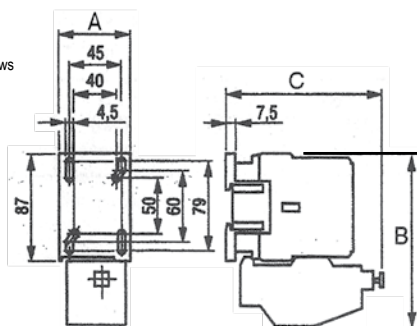

Type	Dimensions - Approximate Inches and (Millimeters)							Coil	VA
	A	B	C	D	E	F	G	Sealed	Inrush
JC25	2.17	5.27	4.06	1.77	1.97	3.11	.18	9VA	88VA
JC32	(55)	(134)	(103)	(45)	(50)	(79)	(4.5)		
JC34	2.17	5.27	5.00	1.77	1.97	3.11	.18	9VA	88VA
	(55)	(134)	(127)	(45)	(50)	(79)	(4.5)		

Starters - Type JC / JC50-JC80

4 Mounting Holes for #10 Screws

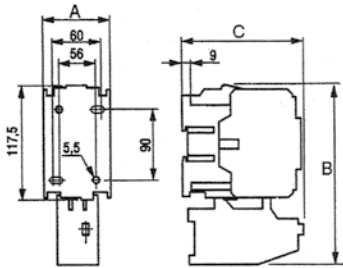

Type	Dimensions - Approximate Inches and (Millimeters)							Coil VA	
	A	B	C	D	E	F	G	Sealed	Inrush
JC50A	2.6	7.23	4.57	3.54	2.38	2.2	.22	15.5VA	191VA
JC65A	(66)	(188)	(117)	(90)	(60)	(56)	(5.5)		
JC80A									

Starters - Type JC / JC95 - JCC5

4 Mounting Holes for #10 Screws

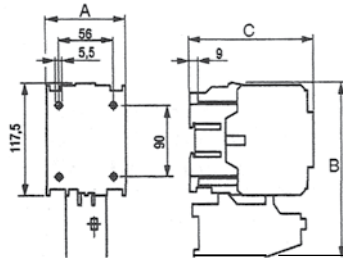

Type	Dimensions - Approximate Inches and (Millimeters)						Coil VA	
	A	B	C	D	E	F	Sealed	Inrush
JC95A	2.95	7.43	4.96	3.54	2.2	.022	15.5VA	191VA
JCC5A	(66)	(188.5)	(126)	(90)	(56)	(5.5)		

Contactors - Type JC / J150 - J309

4 Mounting Holes for #1/4" Bolts

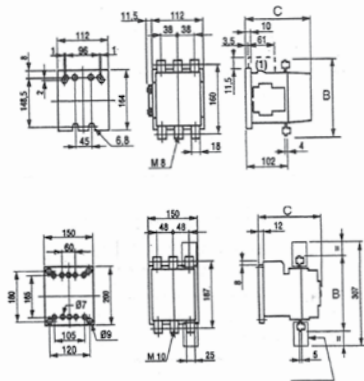

Type	Dimensions - Approximate Inches and (Millimeters)							Coil VA	
	A	B	C	D	E	F	G	Sealed	Inrush
J150C	4.4	7.0	6.5	6.3	5.8	3.5	6.45	32VA	400VA
J185C	(112)	(178)	(166)	(160)	(148.5)	(96)	(164)		
J250B	5.9	8.33	8.2	7.4	7.08	4.72	7.86	60VA	830VA
J309B	(150)	(211.6)	(208)	(187)	(180)	(120)	(200)		

Contactors - Type JC / J420 - J550

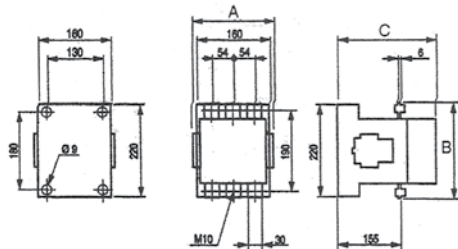

Type	Dimensions - Approximate Inches and (Millimeters)							Coil VA	
	A	B	C	D	E	F	G	Sealed	Inrush
J420C	7.2	8.97	8.97	7.48	7.09	5.12	8.66	23VA	680VA
J550C	(183)	(228)	(228)	(190)	(180)	(130)	(220)		

Contactors - Type JC / J700

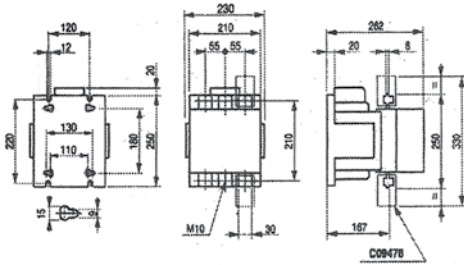

Type	Dimensions - Approximate Inches and (Millimeters)							Coil VA	
	A	B	C	D	E	F	G	Sealed	Inrush
J700B	9.06 (230)	9.84 (250)	10.31 (262)	8.27 (210)	8.66 (220)	4.72 (120)	.47 (12)	25VA	750VA

Overload Relays - Separate Panel Mount

2 Mounting Holes for #8 Screws

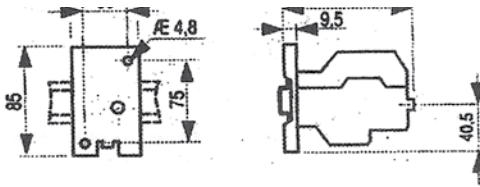

Type	Dimensions - Approximate Inches and (Millimeters)						
	A	B	C	D	E	F	G
JL1 JLXP	1.77 (45)	3.38 (85.8)	4.24 (107.7)	1.38 (35)	2.97 (75)	1.8 (45.7)	.55 (13.5)

2 Mounting Holes for #8 Screws

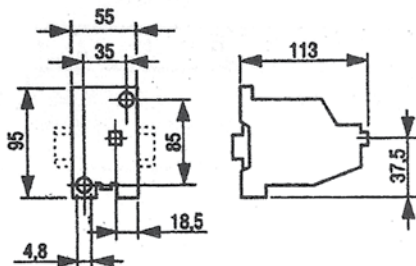

Type	Dimensions - Approximate Inches and (Millimeters)						
	A	B	C	D	E	F	G
JLA2P	2.16 (54.9)	3.75 (95.2)	4.4 (113)	1.38 (35)	3.34 (84.8)	1.83 (46.2)	1.42 (37)

Overload Relays - Separate Panel Mount (JL3 - JL5)

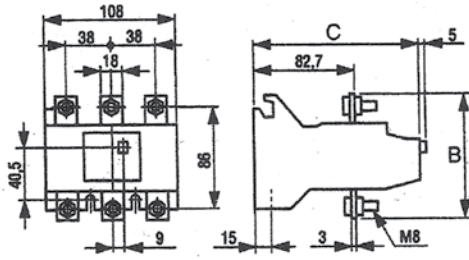

4 Mounting Slots for #1/4" Bolts

Type	Dimensions - Approximate Inches and (Millimeters)							
	A	B	C	D	E	F	G	H
JL3	4.25 (108)	4.14 (105)	5.4 (137)	1.34 (34)	.47 (12)	1.57 (40.5)	2.48 (62.9)	2.75 (70)

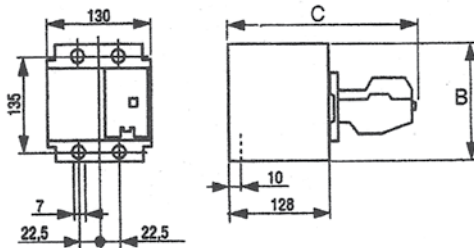

4 Mounting Slots for #1/4" Bolts

Type	Dimensions - Approximate Inches and (Millimeters)						
	A	B	C	D	E	F	G
JL4	5.08 (129.2)	6.90 (177)	9.12 (231.6)	1.67 (42.4)	5.35 (13.5)	3.51 (89.2)	1.85 (46.9)

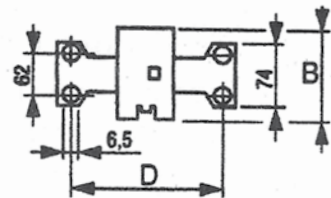
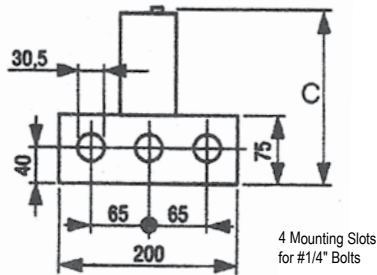

Type	Dimensions - Approximate Inches and (Millimeters)						
	A	B	C	D	E	F	G
JL5	7.9 (200)	3.25 (82)	7.05 (179)	7.13 (181)	2.38 (60.4)	2.93 (74)	.26 (6.5)

Accessories

Front - Mount Auxiliary Contact Block / JCAF_ _

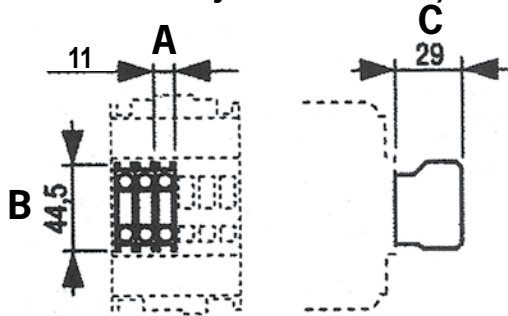

Dimensions - Approximate Inches and (Millimeters)		
A	B	C
.44 (11)	1.77 (44.5)	1.25 (29)

Side - Mount Auxiliary Contact Block / JCAL_ _

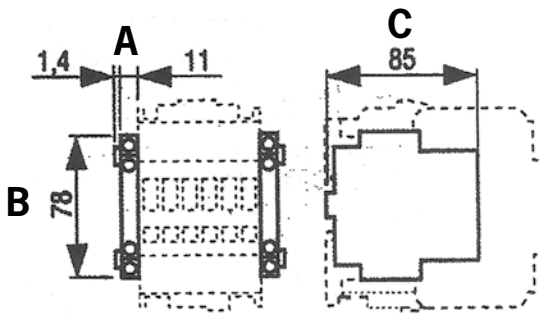

Dimensions - Approximate Inches and (Millimeters)		
A	B	C
.44 (11)	3.11 (78)	3.32 (85)

Mechanical Interlock / JRAA, JRAA02

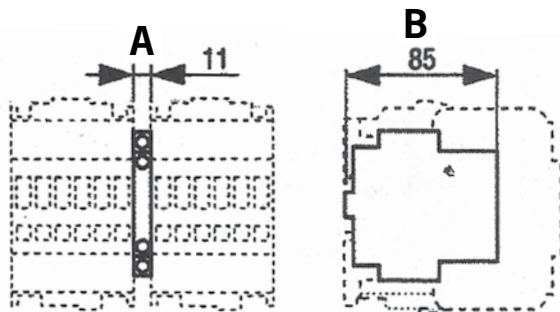

Dimensions - Approximate Inches and (Millimeters)	
A	B
.44 (11)	3.32 (85)

Pneumatic timer / JTAF

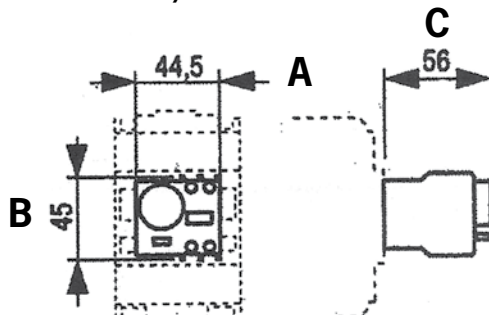

Dimensions - Approximate Inches and (Millimeters)		
A	B	C
1.77 (44.5)	1.8 (45)	2.2 (56)

3-Phase Starter

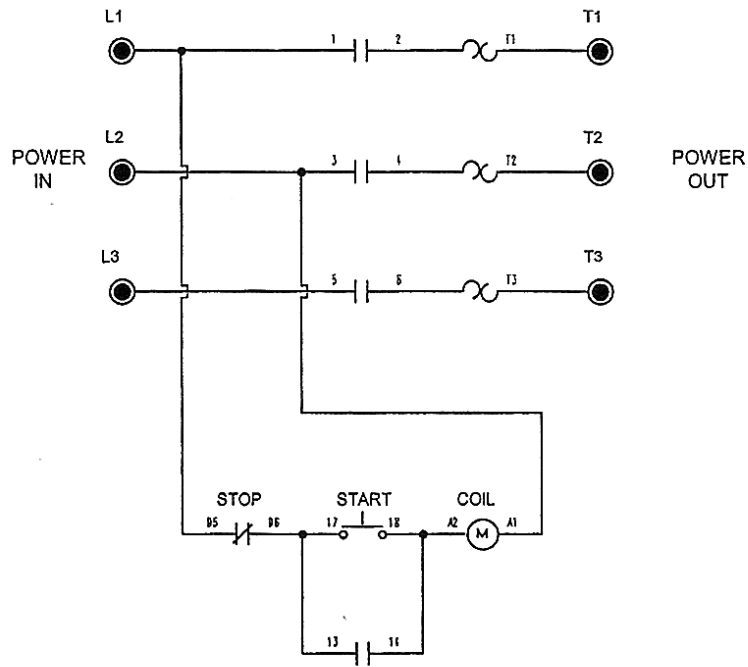

1-Phase Starter

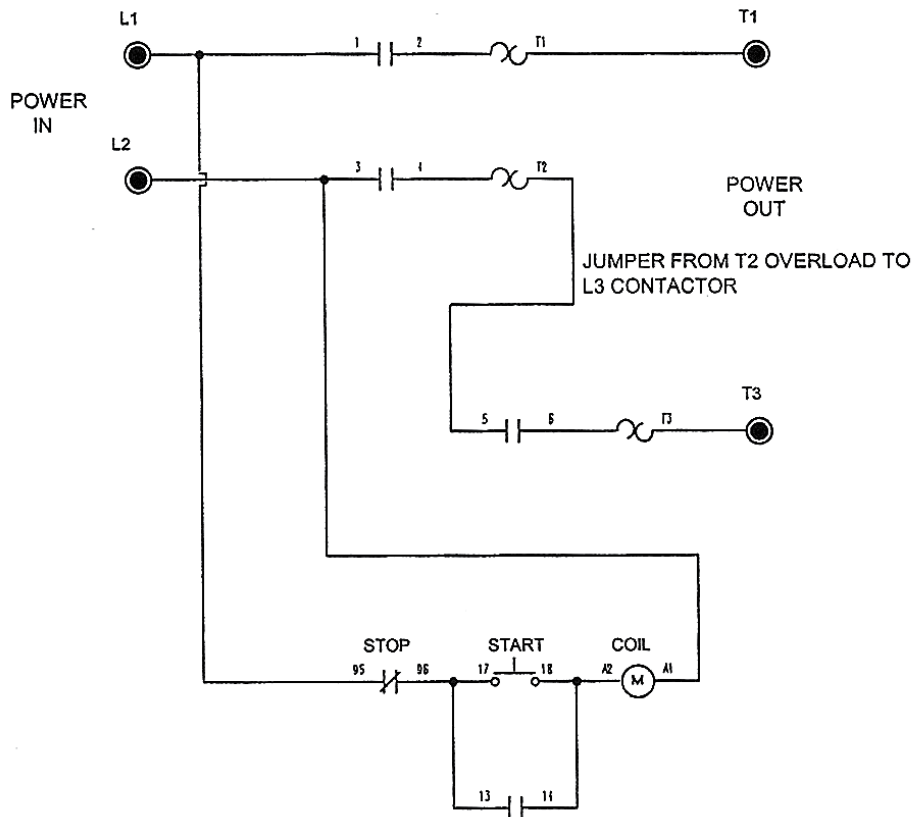

ENCLOSED DIRECT ON-LINE STARTERS



Springer Controls carries a complete line of IEC enclosed, direct on-line, AC starters up to 60 HP or 80 amp. Springer Controls is UL certified (508A), to build starters and custom control panels up to 500 HP. (See section F for custom built starters.)

ENCLOSED DIRECT ON-LINE STARTERS;

Description / Features / Ordering Instructions	B2
Nomenclature - Part Number	B3
Single Phase, Full Voltage Starters (9amp - 80amp).....	B4
Three Phase, Full Voltage Starters (9amp - 32amp).....	B5
Three Phase, Full Voltage Starters (50amp - 80amp).....	B6
Wiring Diagrams.....	B7
Horsepower Motor Ratings.....	B8
Kilowatt Motor Ratings.....	B9

ENCLOSED ON-LINE AC STARTERS; DESCRIPTION & FEATURES

B 2



Description and Features

- Direct On-Line Starters in polycarbonate enclosure. Rated Nema 1, 12, 4 & 4x, IP65
- All contactors and overload relays are UL approved.
- AC3 Inductive Motor rating from 9amp through 80 amp
- Fully assembled single and three phase starters.
- No cover wiring required.
- Full selection of coil voltages and overload relays.
- “Start-Stop” or “Reset” external buttons come standard. (Blank cover or no buttons available on request)



Part# **JC1206P1G-JN**

- 12 amp AC Starter
- 3-phase
- Poly Enclosure - N4x
- Start-Stop Buttons
- Dimensions; 7" x 3½" X 5½"
- 120V AC coil
- Overload Relay; 8-12 amps

Ordering Information

- Determine Single or Three Phase application.
- Determine motor HORSEPOWER or FULL LOAD AMPS (FLA) of the motor.
- Select complete Part Number from designated table.
- “Nomenclature” (page B3) to order non-listed or non-standard starters.
- For starters that are NOT direct on-line, see “Engineered Products” in section F of catalog for custom-built starters.



Part# **JC6506P1K-SH**

- 65 amp AC Starter
- 3-phase
- Poly Enclosure - N4x
- Start-Stop Buttons
- Dimensions; 12" x 8" X 7"
- 240V AC coil
- Overload Relay; 54-65 amps

Nomenclature; AC Starters

Example Part #: **#JC0906P1G-JM**
 Description: 9 amp contactor, wired 3 phase, polycarbonate enclosure with start-stop/reset button, 120volt AC coil, 5.5 - 8.5 current range.



Contactor Size	
JC09	9amp
JC12	12amp
JC18	18amp
JC25	25amp
JC32	32amp
JC50	50amp
JC65	65amp
JC80	80amp

Wiring	
0	Three Phase
1	Single Phase

Enclosure Type	
6	Poly Encl.

Button Configuration	
P1	Start-Stop
R1	Reset Only
S1	No Buttons

Overload Relay*	
Current Range	Suffix
2.5 - 4.0	K
4.0 - 6.3	L
5.5 - 8.5	M
8.0 - 12.0	N
10.0 - 16.0	P
14.5 - 18.0	S
17.5 - 22.0	T
21.0 - 26.0	U
25.0 - 32.0	V
30.0 - 40.0	W

*JC09 through JC32 contactors; see table on page A13 for JL2 O/L relays.

AC Coils	
1	24V
J	120V
L	208V
S	240V
N	277V
U	480V

Enclosure Size; H x W x D		Contactors used
G	7" x 3½" x 5½"	JC09, JC12, JC18
B	7½" x 4" x 6"	JC25, JC32
K	12" x 8" x 7"	JC50, JC65, JC80

ENCLOSED AC STARTERS - SINGLE PHASE

Single Phase, Full Voltage, Across the Line Starters; 9amp - 80amp

B 4



9amp Starter; "Start-Stop" Button



9amp Starter; "Reset only" Button

Horsepower Single Phase (Full Load Amps)		Contactor Series	Overload Relay Range (O/L part#)	Coil Voltage	Complete Part Number* Start-Stop Button	Complete Part Number* Reset only Button	Price
115V	230V						
---	1/4 (2.9)	JC09	2.5 - 4.0 (JL1K)	115V	---	---	\$306.00
---				230V	JC0916P1G-SK	JC0916R1G-SK	
1/6 (4.4)	1/2 (4.9)	JC09	4.0 - 6.3 (JL1L)	115V	JC0916P1G-JL	JC0916R1G-JL	\$309.00
				230V	JC0916P1G-SL	JC0916R1G-SL	
1/3 (7.2)	3/4 (6.9)	JC09	5.5 - 8.5 (JL1M)	115V	JC0916P1G-JM	JC0916R1G-JM	\$309.00
				230V	JC0916P1G-SM	JC0916R1G-SM	
1/2 (9.8)	1.0 (8.0)	JC09	8.0 - 12.0 (JL1N)	115V	JC0916P1G-JN	JC0916R1G-JN	\$309.00
				230V	JC0916P1G-SN	JC0916R1G-SN	
---	1.5 (10.0)	JC12	8.0 - 12.0 (JL1N)	115V	---	---	\$347.00
---				230V	JC1216P1G-SN	JC1216R1G-SN	
---	2.0 (12.0)	JC12	10.0 - 16.0 (JL1P)	115V	---	---	\$347.00
---				230V	JC1216P1G-SP	JC1216R1G-SP	
3/4 (13.8)	---	JC18	10.0 - 16.0 (JL1P)	115V	JC1816P1G-JP	JC1816R1G-JP	\$372.00
				230V	---	---	
1.0 (16.0)	3.0 (17.0)	JC18	14.5 - 18.0 (JL1S)	115V	JC1816P1G-JS	JC1816R1G-JS	\$372.00
				230V	JC1816P1G-SS	JC1816R1G-SS	
1.5 (20.0)	---	JC25	17.5 - 22.0 (JL1T)	115V	JC2516P1B-JT	JC2516R1B-JT	\$416.00
				230V	---	---	
2.0 (24.0)	---	JC25	21.0 - 26.0 (JL1U)	115V	JC2516P1B-JU	JC2516R1B-JU	\$416.00
				230V	---	---	
---	5.0 (28.0)	JC32	25.0 - 32.0 (JL1V)	115V	---	---	\$460.00
---				230V	JC3216P1B-SV	JC3216R1B-SV	
3.0 (34.0)	7.5 (40.0)	JC50	30.0 - 43.0 (JL2E)	115V	JC5016P1K-JE	JC5016R1K-JE	\$774.00
				230V	JC5016P1K-SE	JC5016R1K-SE	
---	10 (50.0)	JC50	42.0 - 55.0 (JL2G)	115V	---	---	\$774.00
---				230V	JC5016P1K-SG	JC5016R1K-SG	
5.0 (56.0)	---	JC65	54.0 - 65.0 (JL2H)	115V	JC6516P1K-JH	JC6516R1K-JH	\$803.00
				230V	---	---	
7.5 (80.0)	---	JC80	64.0 - 82.0 (JL2J)	115V	JC8016P1K-JJ	JC8016R1K-JJ	\$913.00
				230V	---	---	

*See "Nomenclature" page B3 for panel size.

Discount Schedule SC-70

ENCLOSED AC STARTERS - THREE PHASE

B5

Three Phase, Full Voltage, Across the Line Starters; 9amp - 32amp

Horsepower Three Phase (Full Load Amps)			Contactor Series	Overload Relay Range (O/L part#)	Coil Voltage	Complete Part Number* Start-Stop Button	Complete Part Number* Reset only Button	Price
115V	230V	460V						
--	--	1/2 (1.1)	JC09	1.0 - 1.5 (JL1G)	115V	--	--	\$306.00
					230V	--	--	
					460V	JC0906P1G-UG	JC0906R1G-UG	
--	--	3/4 (1.6)	JC09	1.3 - 1.9 (JL1H)	115V	--	--	\$306.00
					230V	--	--	
					460V	JC906P1G-UH	JC0906R1G-UG	
--	1/2 (2.2)	1.0 (2.1)	JC09	1.8 - 2.7 (JL1J)	115V	--	--	\$306.00
					230V	JC0906P1G-SJ	JC0906R1G-SJ	
					460V	JC906P1G-UJ	JC0906R1G-UJ	
--	3/4 (3.2)	1.5/2.0 (3.4)	JC09	2.5 - 4.0 (JL1K)	115V	--	--	\$306.00
					230V	JC0906P1G-SK	JC0906R1G-SK	
					460V	JC0906P1G-UK	JC0906R1G-UK	
1/2 (4.4)	1.0 (4.2)	3.0 (4.8)	JC09	4.0 - 6.3 (JL1L)	115V	JC0906P1G-JL	JC0906R1G-JL	\$309.00
					230V	JC0906P1G-SL	JC0906R1G-SL	
					460V	JC0906P1G-UL	JC0906R1G-UL	
3/4 (6.4)	1.5/2.0 (6.8)	5.0 (7.6)	JC09	5.5 - 8.5 (JL1M)	115V	JC0906P1G-JM	JC0906R1G-JM	\$309.00
					230V	JC0906P1G-SM	JC0906R1G-SM	
					460V	JC0906P1G-UM	JC0906R1G-UM	
1.0 (8.4)	3.0 (9.6)	7.5 (11.0)	JC12	8.0 - 12.0 (JL1N)	115V	JC1206P1G-JN	JC1206R1G-JN	\$347.00
					230V	JC1206P1G-SN	JC1206R1G-SN	
					460V	JC1206P1G-UN	JC1206R1G-UN	
1.5/2.0 (13.6)	--	10.0 (14.0)	JC18	10.0 - 16.0 (JL1P)	115V	JC1806P1G-JP	JC1806R1G-JP	\$372.00
					230V	--	--	
					460V	JC1806P1G-UP	JC1806R1G-UP	
--	5 (15.2)	--	JC18	14.5 - 18.0 (JL1S)	115V	--	--	\$372.00
					230V	JC1806P1G-SS	JC1806R1G-SS	
					460V	--	--	
--	--	15.0 (21.0)	JC25	17.5 - 22.0 (JL1T)	115V	--	--	\$416.00
					230V	--	--	
					460V	JC2506P1B-UT	JC2506R1B-UT	
--	7.5 (22.0)	--	JC25	21.0 - 26.0 (JL1U)	115V	--	--	\$416.00
					230V	JC2506P1B-SU	JC2506R1B-SU	
					460V	--	--	
--	10.0 (28.0)	20.0 (27.0)	JC32	25.0 - 32.0 (JL1V)	115V	--	--	\$460.00
					230V	JC3206P1B-SV	JC3206R1B-SV	
					460V	JC3206P1B-UV	JC3206R1B-UV	
--	--	25.0 (34.0)	JC32	30.0 - 40.0 (JL1W)	115V	--	--	\$482.00
					230V	--	--	
					460V	JC3206P1B-UW	JC3206R1B-UW	

*See "Nomenclature" page B3 for panel size

Discount Schedule SC-70

ENCLOSED AC STARTER - THREE PHASE

B 6

Three Phase, Full Voltage, Across the Line Starters; 50amp - 80amp*



65 amp Starter "Stop-Start"

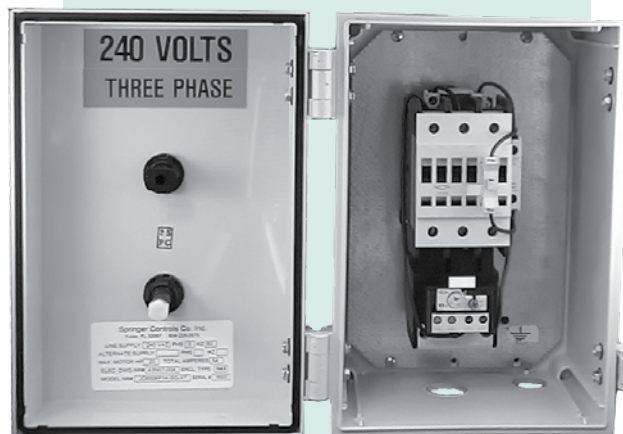

65 amp Starter; open

Horsepower Three Phase (Full Load Amps)			Contactor Series	Overload Relay Range (O/L part#)	Coil Voltage	Complete Part Number* Start-Stop Button	Complete Part Number* Reset only Button	Price
115V	230V	460V						
---	15 (42.0)	30 (40.0)	JC50	30 - 43 (JL2E)	115V	---	---	\$774.00
					230V	JC5006P1K-SE	JC5006R1K-SE	
					460V	JC5006P1K-UE	JC5006R1K-UE	
---	---	40 (52.0)	JC50	42 - 55 (JL2G)	115V	---	---	\$774.00
					230V	---	---	
					460V	JC5006P1K-UG	JC5006R1K-UG	
---	20 (54.0)	---	JC65	54 - 65 (JL2H)	115V	---	---	\$803.00
					230V	JC6506P1K-SH	JC6506R1K-SH	
					460V	---	---	
---	25 (68.0)	50 (65.0)	JC80	64 - 82 (JL2J)	115V	---	---	\$913.00
					230V	JC8006P1K-SJ	JC8006R1K-SJ	
					460V	JC8006P1K-UJ	JC8006R1K-UJ	
---	---	60 (77.0)	JC80	64 - 82 (JL2J)	115V	---	---	\$913.00
					230V	---	---	
					460V	JC8006P1K-UJ	JC8006R1K-UJ	

*See "Engineered Products", Section F, for starters larger than 80amp or for any custom built starters.

Discount Schedule SC-70

Typical Wiring Diagram "JC" Series

Three Phase Starter

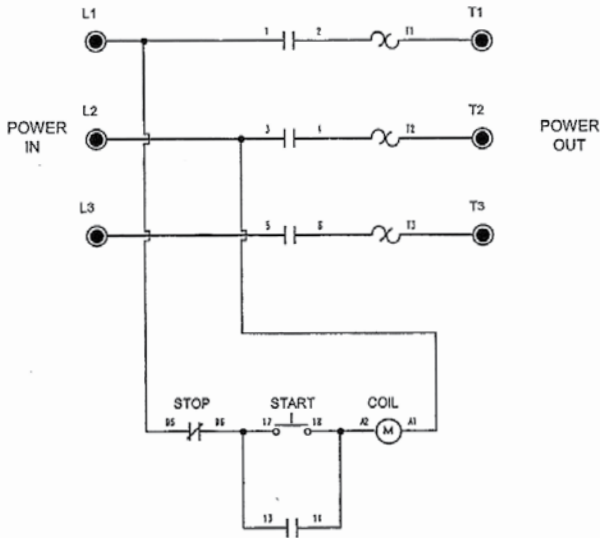

Single Phase Starter

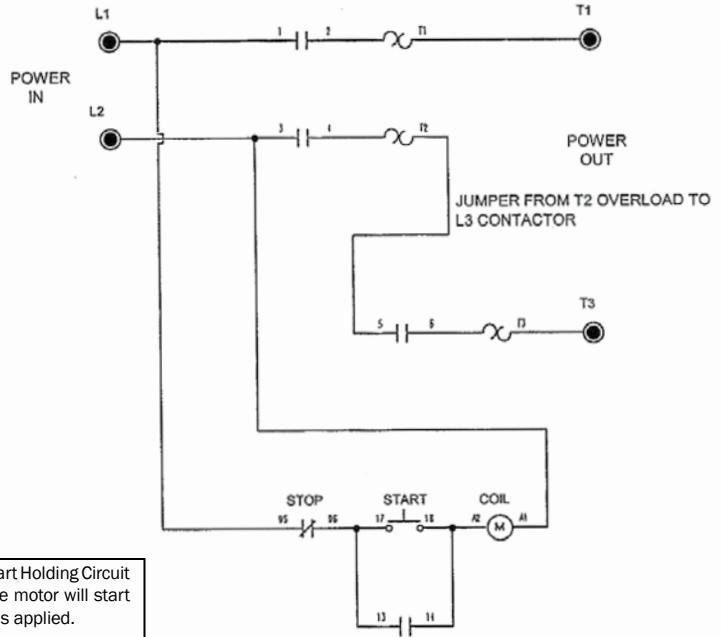

Reset Only - The Start Holding Circuit is removed and the motor will start as soon as power is applied.
Overload contact 95-96 remains in the control circuit.

Note: Wire L1 & L2 control supply voltage only when coil voltage is the same as the line voltage.

Overload Relay Diagram

See Page A27 for detailed description of the dial settings.

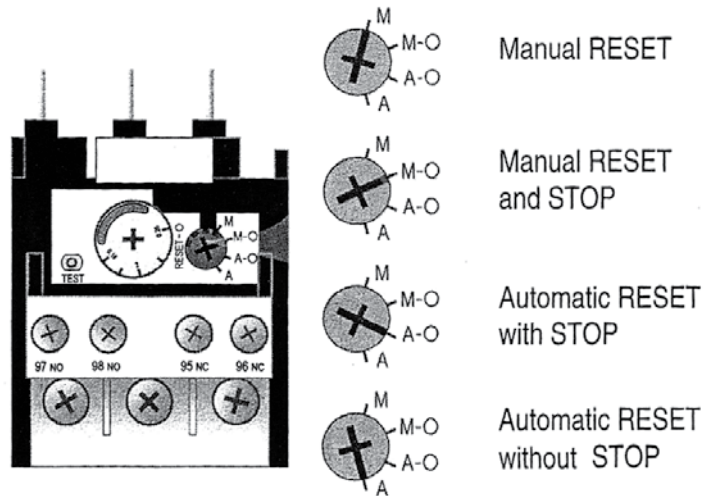

HORSEPOWER MOTOR RATINGS

B 8

Full-Load Motor-Running Currents in Amperes
Corresponding to Various AC Horsepower Motor Ratings

The table below provides the average full-load currents of squirrel cage motors in accordance with IEC conventions. These are given only as a guide. Refer to the actual motor nameplate for full-load current values.

H.P.	110V - 120V		220V - 240V ^{1,2}		380V - 415V		440V - 480V		550V - 600V		2.3 KV	4.16 KC
	Single Phase	Three Phase	Single Phase	Three Phase	Single Phase	Three Phase	Single Phase	Three Phase	Single Phase	Three Phase	Three Phase	Three Phase
1/10	3.0	---	1.5	---	---	---	---	---	---	---	---	---
1/8	3.8	---	1.9	---	---	---	---	---	---	---	---	---
1/6	4.4	---	2.2	---	1.4	---	---	---	---	---	---	---
1/4	5.8	---	2.9	---	1.85	---	---	---	---	---	---	---
1/3	7.2	---	3.6	---	2.32	---	---	---	---	---	---	---
1/2	9.8	4.4	4.9	2.2	3.19	1.28	2.5	1.1	2.0	0.9	---	---
3/4	13.8	6.4	6.9	3.2	4.47	1.78	3.5	1.6	2.8	1.3	---	---
1	16.0	8.4	8.0	4.2	5.12	2.30	4.0	2.1	3.2	1.7	---	---
1.5	20.0	12.0	10.0	6.0	6.38	3.32	5.0	3.0	4.0	2.4	---	---
2	24.0	13.6	12.0	6.8	7.66	4.34	6.0	3.4	4.8	2.7	---	---
3	34.0	19.2	17.0	9.6	10.87	6.14	8.5	4.8	6.8	3.9	---	---
5	56.0	30.4	28.0	15.2	17.90	9.71	14.0	7.6	11.2	6.1	---	---
7.5	80.0	44.0	40.0	22.0	26.80	14.00	21.0	11.0	16.0	9.0	---	---
10	100.0	56.0	50.0	28.0	33.2	17.90	26.0	14.0	20.0	11.0	---	---
15	135.0	84.0	68.0	42.0	---	26.80	34.0	21.0	27.0	17.0	---	---
20	---	108.0	88.0	54.0	---	34.50	44.0	27.0	35.0	22.0	---	---
25	---	136.0	110.0	68.0	---	43.50	55.0	34.0	44.0	27.0	---	---
30	---	160.0	136.0	80.0	---	51.20	68.0	40.0	54.0	32.0	---	---
40	---	208.0	176.0	104.0	---	66.50	88.0	52.0	70.0	41.0	---	---
50	---	260.0	216.0	130.0	---	83.10	108.0	65.0	86.0	52.0	---	---
60	---	---	---	154.0	---	103.0	---	77.0	---	62.0	16.	9.
75	---	---	---	192.0	---	128.0	---	96.0	---	77.0	20.	11.
100	---	---	---	248.0	---	165.0	---	124.0	---	99.0	26.	14.3
125	---	---	---	312.0	---	208.0	---	156.0	---	125.0	31.	17.
150	---	---	---	360.0	---	240.0	---	180.0	---	144.0	37.	20.
200	---	---	---	480.0	---	320.0	---	240.0	---	192.0	49.	27.
250	---	---	---	602.0	---	403.0	---	302.0	---	242.0	60.	33.
300	---	---	---	---	---	482.0	---	361.0	---	289.0	72.	40.
350	---	---	---	---	---	560.0	---	414.0	---	336.0	83.	46.
400	---	---	---	---	---	636.0	---	477.0	---	382.0	95.	52.
500	---	---	---	---	---	786.0	---	590.0	---	472.0	118.	65.

Notes:

1. To obtain F.L.C. for 200 and 208 volt motors multiply 230 volts values by 1.15 and 1.10 respectively.
2. To obtain F.L.C. for 265 and 277 volt motors multiply 230 volts values by .87 and .83 respectively.

KILOWATT MOTOR RATINGS

B9

The table below provides the average full-load currents of squirrel cage motors in accordance with IEC conventions. These are given only as a guide. Refer to the actual motor nameplate for full-load current values.

Power Kilowatts	Single-Phase Motor		Three-Phase Motor					
	120V A	240V A	230V A	400V A	415V A	440V A	500V A	690V A
0.37	3.9	3.6	2	.98	—	0.99	1	—
0.55	5.2	4.8	2.8	1.5	—	1.36	1.21	—
0.75	6.6	6.1	3.6	1.9	2	1.68	1.5	—
1.1	9.6	8.8	5.2	2.5	2.5	2.37	2	—
1.5	12.7	11.7	6.8	3.4	3.5	3.06	2.6	—
1.8	15.7	14.4	—	—	—	—	—	—
2.2	18.6	17.1	9.6	4.8	5	4.42	3.8	—
3	24.3	22.2	—	6.3	6.5	5.77	5	3.5
3.7	—	—	15.2	—	—	—	—	—
4	29.6	27.1	—	8.1	8.4	7.9	6.5	4.9
4.4	34.7	31.8	—	—	—	—	—	—
5.2	39.8	36.5	—	—	—	—	—	—
5.5	42.2	38.7	22	11	11	10.4	9	6.7
6	44.5	40.8	—	—	—	—	—	—
7	49.5	45.4	—	—	—	—	—	—
7.5	54.4	50	28	14.8	14	13.7	12	9
9	—	—	—	18.1	17	16.9	13.9	10.5
11	—	—	42	21	21	20.1	18.4	12.1
15	—	—	54	28.5	28	26.5	23	16.5
18.5	—	—	68	35	35	32.8	28.5	20.2
22	—	—	80	42	40	39	33	24.2
30	—	—	104	57	55	51.5	45	33
37	—	—	130	69	66	64.0	55	40
45	—	—	154	81	80	76	65	46.8
55	—	—	192	100	100	90	80	58
75	—	—	248	131	135	125	105	75.7
90	—	—	312	162	165	146	129	94
110	—	—	360	195	200	178	156	113
132	—	—	—	233	240	215	187	135
—	—	—	480	222	260	236	207	—
160	—	—	—	285	280	256	220	165
—	—	—	600	—	—	—	—	—
200	—	—	—	352	340	321	281	203
220	—	—	720	388	385	353	310	224
250	—	—	840	437	425	401	360	253
280	—	—	—	—	—	—	—	—
315	—	—	—	555	535	505	445	321
—	—	—	1080	—	—	—	—	—
355	—	—	—	605	580	549	500	350
—	—	—	1200	—	—	—	—	—
400	—	—	—	675	650	611	540	390
450	—	—	1440	—	—	—	—	—
500	—	—	—	855	820	780	680	494
560	—	—	—	950	920	870	760	549
630	—	—	—	1045	1020	965	850	605
710	—	—	—	1200	1140	1075	960	694
800	—	—	—	—	1320	1250	1100	790
900	—	—	—	—	1470	1390	1220	880



NOTES

B 10

MANUAL MOTOR STARTERS



SPRINGER
controls company

Index
C

Springer Controls manual motor starters are 3-pole horsepower rated switches that combine motor thermal overload protection and magnetic short circuit protection in one compact unit. The switches offer motor protection circuit breaker up to 32 amps.

MANUAL MOTOR STARTERS;

Description / Features	C2
GMK Manual Motor Starters (up to 32 amps)	C3
Engineering Data	C4
Wiring Diagrams	C5
Dimensions	C6

DESCRIPTION / FEATURES

C2

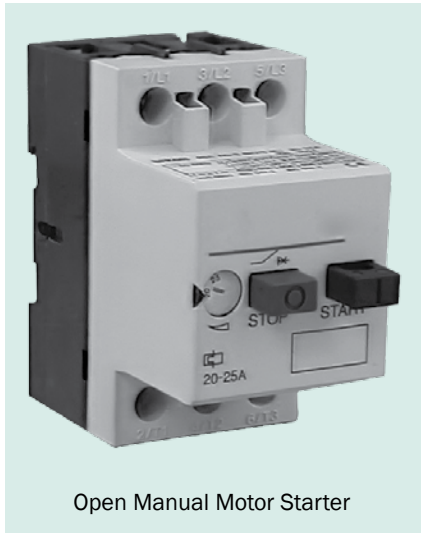

Open Manual Motor Starter



Surface Mount Starter (IP55)



Flush Mount Starter (IP55)

Description

Model GMK Motor Protection Switch is a three pole horsepower rated switch which combines motor thermal overload protection and magnetic short circuit protection in one compact unit. The GMK is ideal for applications requiring multi-motor operation.

UL permits Group Fusing for motors up to 10 amperes full load current. This provides the option for grouping a number of motors under one branch circuit disconnect and fuse set. This saves panel space and additional component cost.

Remote control operation and low voltage protection can be provided by adding a Type "JM" Contactor in series with the motor protection switch.

Features

- Motor protection circuit breaker up to 32 amps.
- Manual operation using start-stop push buttons.
- All poles open for both thermal and magnetic trips.
- Differential protection against asymmetrical overloads (single phase protection).
- Class 10 overload protection.
- Ambient temperature compensation between -5 °C and +40 °C.
- Instant magnetic trip when the current passing through the relay reaches 12 times maximum value of the thermal setting.
- Easily accessible Terminals protected against accidental contact.
- Easy Din Rail mounting or panel mounting with screws.
- UL Listed, CSA Approved and meets international standards.

GMK MANUAL MOTOR STARTER

Manual Motor Starter - Type GMK

Motor Full Load Current Range		Maximum Single Phase Horsepower			Maximum Three Phase Horsepower			Magnetic Tripping Current Ampere	UL Requirements		Catalog No.	Price
Min.A	Max.A	115V	200V	230V	230V	460V	575V		Individual Motor Class K5 Max. Fuse Ampere	Group Fusing Max. Fuse Ampere		
0.1	0.16	---	---	---	---	---	---	1.9	15	100	GMKO-A	\$144.00
0.16	0.25	---	---	---	---	---	---	3.0	15	100	GMKO-B	\$144.00
0.25	0.4	---	---	---	---	---	---	4.8	15	100	GMKO-C	\$144.00
0.4	0.63	---	---	---	---	---	---	7.5	15	100	GMKO-D	\$144.00
0.63	1.0	---	---	---	---	1/2	1/2	12	15	100	GMKO-E	\$144.00
1.0	1.6	---	---	1/10	---	3/4	1	19	15	100	GMKO-F	\$164.00
1.6	2.5	---	1/8	1/6	1/2	1	1½	30	15	100	GMKO-G	\$164.00
2.5	4.0	1/8	1/4	1/3	1	2	3	48	15	45	GMKO-H	\$164.00
4.0	6.3	1/4	1/2	1/2	1½	3	5	75	20	45	GMKO-I	\$164.00
6.3	10.0	1/2	1	1½	3	5	7½	120	35	80	GMKO-J	\$164.00
10.0	16.0	1	2	2	5	10	10	190	60	---	GMKO-K	\$205.00
16.0	20.0	1½	3	3	---	---	15	240	80	---	GMKO-L	\$205.00
20.0	25.0	2	---	---	7½	15	20	300	90	---	GMKO-M	\$205.00
25.0	32.0	2	---	5	10	20	25	380	90	---	GMKO-N	\$230.00

Note:

1. Single phase horsepower ratings are based on wiring the 3 starter poles in series.
2. For group motor installations, use lowest maximum fuse size for the group of starters.

ORDERING INFORMATION

- Select starter based on the overload current range required for a given motor. This current range is determined from the motor Full Load Ampere rating and Motor Service Factor usually found on the motor nameplate.
- Engineering data page C4
- Wiring schematics page C5
- Dimension page C6

Enclosures and Accessories

Surface Mounting

Flush Mounting



- Made in thermoplastic material.
- Equipped with four cable entries (PG16) and one neutral connection.

			Catalog No.	Price
Surface Mount	General Purpose	IP41	GMS04	\$49.00
	Dust & Water Protection	IP55	GMS05	\$73.00
Flush Mount	General Purpose	IP41	GME04	\$49.00
	Dust & Water Protection	IP55	GME05	\$73.00

Auxiliary Contact Blocks Side Mounting

	Catalog No.	Price
1 NO + 1NC	GMAL11N	\$32.00
2 NO	GMAL20N	\$32.00

Three Phase Busbar Block

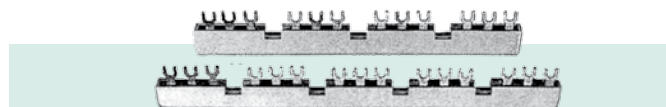

	Catalog No.	Price
4 units Ui 660V Ie 80A - length 207mm	GMVE4	consult factory
5 units Ui 660V Ie 80A - length 261mm	GMVE5	
Plastic cover for unused 3 terminatals	GMVEP	

Discount Schedule SC-70

ENGINEERING DATA

C 4

General

Conformity to Standards		IEC 947-2, IEC 947-4-1, VDE 0660	
Approvals		US, CSA	
Rated Thermal Current (I _{th}) at 40 °C		25A	
Rated Insulation Voltage (Ui)		690V	
Rated Operational Voltage (Ue)		AC	690V, 40/60Hz
(See Application Diagram)		DC	220V, with or without earth connection
Terminal Type		M4, Pozidriv, safety flange screws	
Wiring Capacity	Rigid Wire	min.	2 wires of 0.75 mm ²
		max.	2 wires of 6 mm ²
	Flexible Wire	min.	2 wires of 0.75 mm ²
		max.	2 wires of 4 mm ²

Main Circuit

Category		AC3, DC4	
Operational Frequency Limits		40 to 60Hz	
Opening Time		aprox. 7ms	
Mechanical Endurance		10 ⁵ operations	
Electrical Endurance Category AC3		10 ⁵ operations	
Maximum Operating Rate		40 operations/hour	
Total Dissipated power at Rated Thermal Current and Hot State		6W	
Tripping Characteristics			
Thermal	Symmetrical Overloads	Class 10 (see curve 1, tripping curve)	
	Asymmetrical Overloads (phase failure)	To IEC 947-4-1 (see curve 2, tripping curve)	
	Temperature Compensation	-5 to +40 °C	
Magnetic		12 x I _e (I _e = max. thermal setting value)	
Stunt Release	Operating voltage limits	0.7 - 1.2 U _e 100% ED	
	Consumption AC	2.2 VA	
	DC	1W	
Undervoltage Release	Operational Voltages Limits	0.85 - 1,1 U _e 100% ED	
	Breaking Voltage Limits	0.75 - 0.35 U _e	
	Consumption	2.2 VA 1W	

Tripping Curve

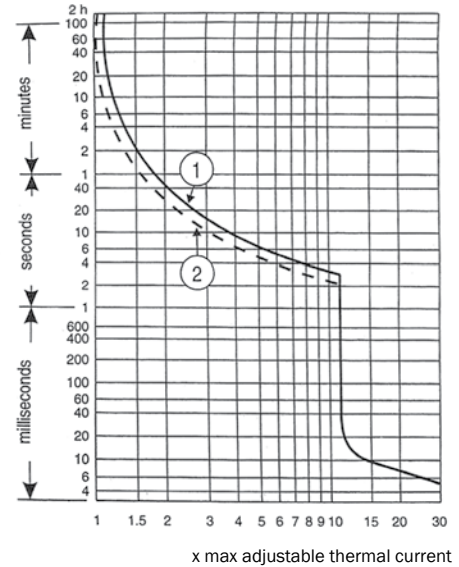

- ① Thermal trip, operating with 3-phases
- ② Thermal-differential trip (from cold) operating with 2-phases

Wiring Diagram

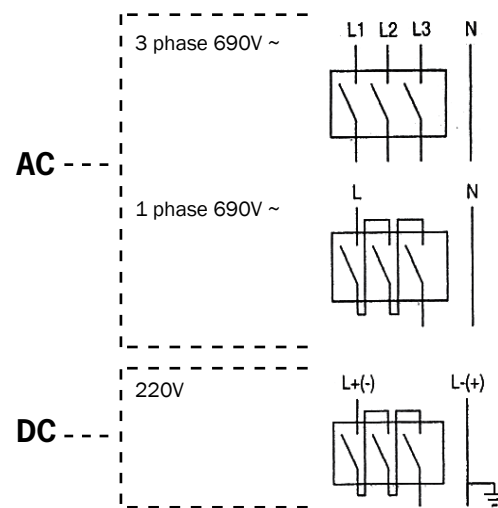

It is recommended to include auxiliary contact number GMAL11N in the control circuit, when using motor protection switches along with a magnetic contactor. It will ensure that the contactor coil is disconnected when the motor protection switch is off. This contact can be wired as shown in the diagram.

3 Phase Wiring using IEC Contactor for Remote Start

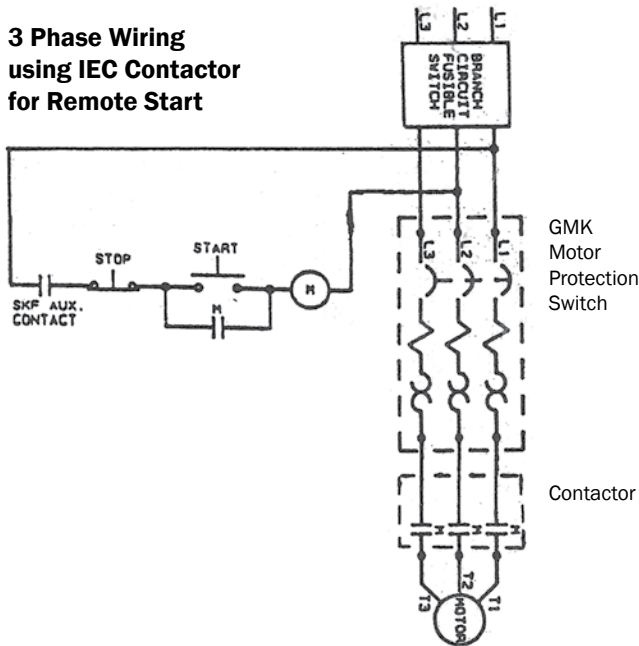

Single Phase Wiring

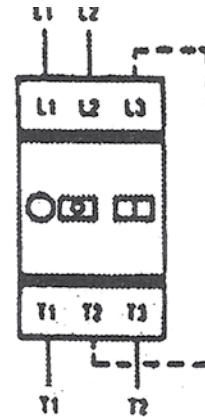

For single phase motors, the 3 poles of the starter must be wired in series by adding a jumper between terminals L3 and T2 as shown.

Group Fusing Application

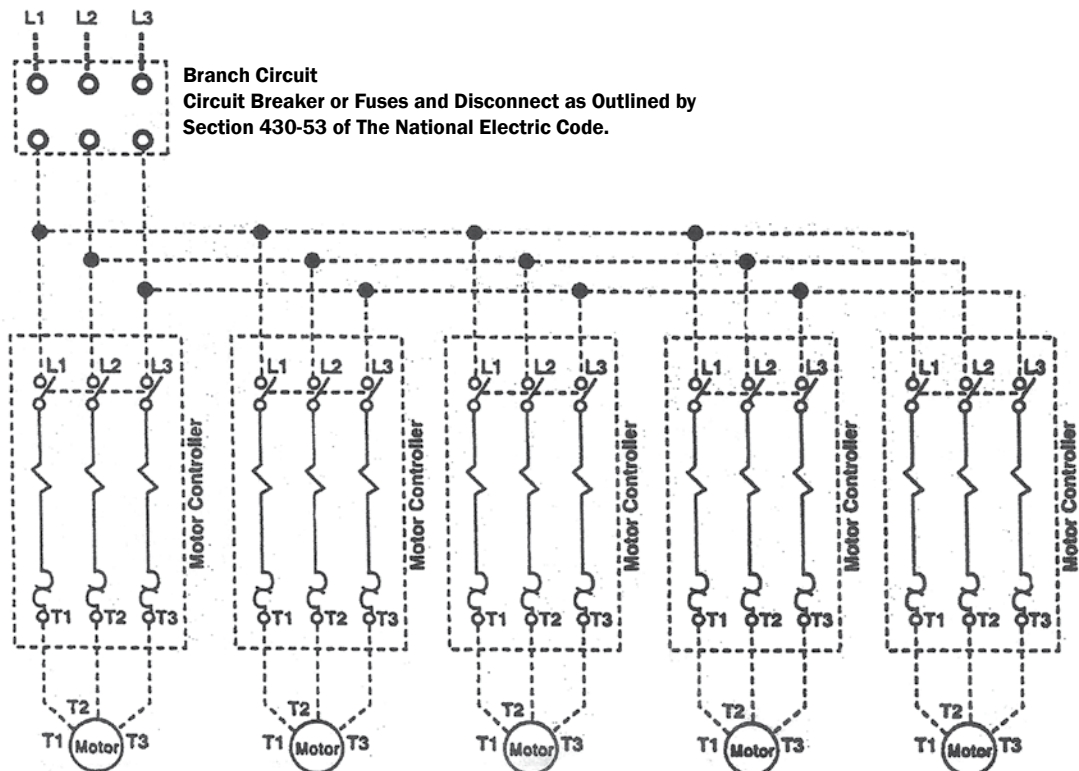

Typical Schematic Diagram; Group Installation of Manual Motor Controller

DIMENSIONS

Motor Protection Circuit Breaker

C6

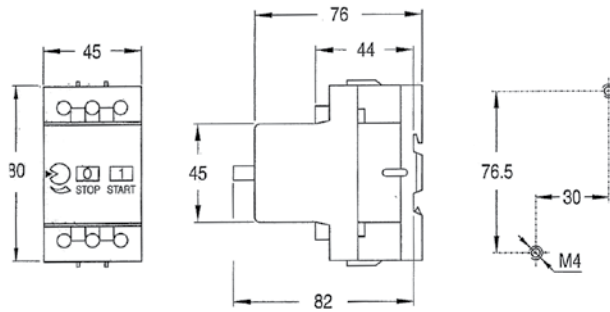

Auxiliary Contact Block

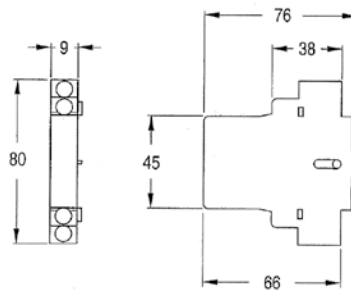

Surface Mounting Enclosure (GMS0_)

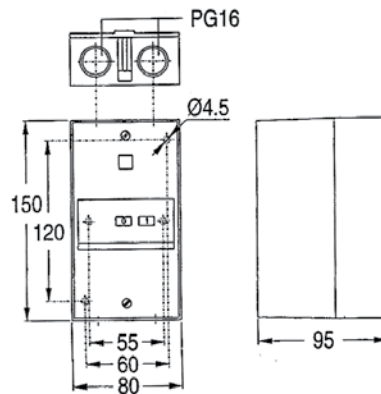

Flush Mounting Enclosure (GME0_)

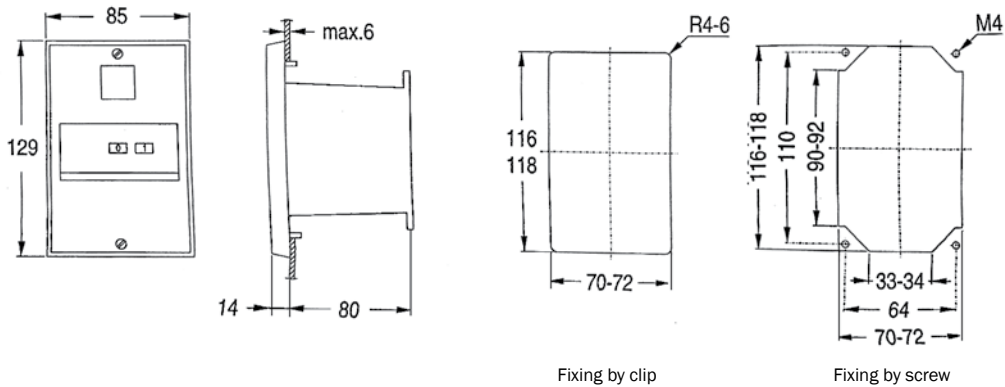

DEFINITE PURPOSE CONTACTORS

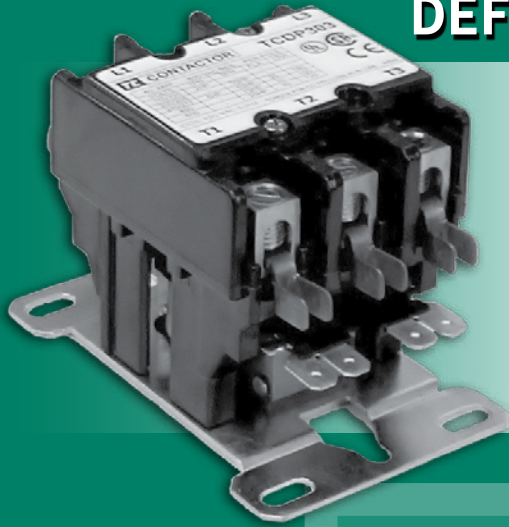

SPRINGER
controls company

Index
D

Springer Controls Definite Purpose Contactors are used in applications where the control requirements are well defined. This includes the controls of motors, power supplies, heating elements, lighting, HVAC fans and compressors.

Springer Controls maintains a large inventory of 25, 30 and 40 amp contactors as well as 50 amp through 90 amp. The contactors are available in 1, 2 and 3 poles along with a full range of coil voltages. All contactors are UL approved.

DEFINITE PURPOSE CONTACTORS;

Description / Technical Specifications	D2
TCDP Contactors; 1 - 3 pole, 20 - 40 amps	D3
Dimensions	D4

TECHNICAL SPECIFICATIONS

D2

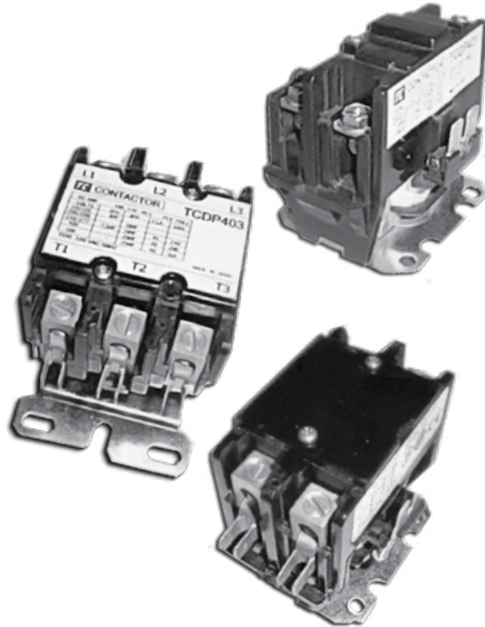

Description

- DP Contactors are used for control of Motors, Power supplies, Heating Elements, Lighting, HVAC Fans and Compressors.
- Available in 20 amp, 30 amp and 40 amp current rating.
- Contact Springer for pricing on 50 amp through 90 amp contactors.
- 1, 2 & 3 pole available.
- Full range of coil voltages available

Environment

- Maximum Operating Altitude: 2000 meters above sea level.
- Ambient Air Temperature: -40° to 65° Celsius
- Ambient Air Dampness: 45% to 85% RH
- Coil Voltage: 80% - 105% rated voltage.

Technical Data

- Expected Life: 200,000 operations on full load.
- AC Coil: 2 million operations (mechanical)
- Minimum Contact Current: 3A @ 120V AC
- Normal VA: Inrush 65 VA, Sealed 7.5 VA
- Duty Cycle: Continuous
- Initial Insulation Resistance: 100 mega-ohms minimum
- UL and CE certified



Part Number Nomenclature

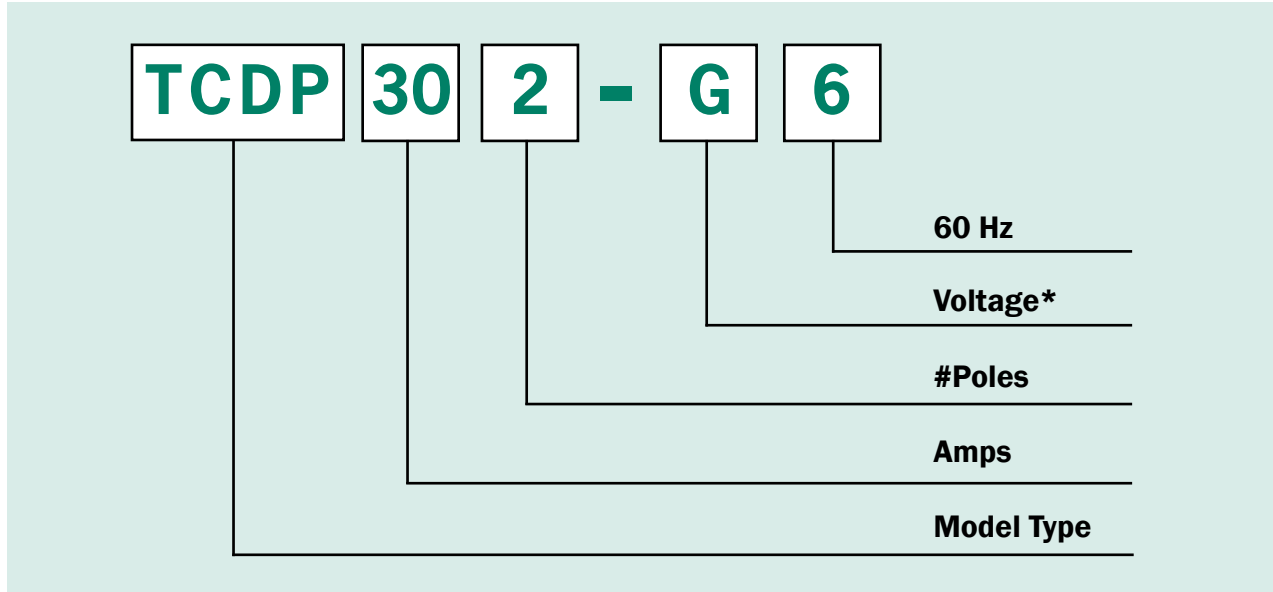

D3

• Consult factory for 50, 60, 75, 90 amp contactors.

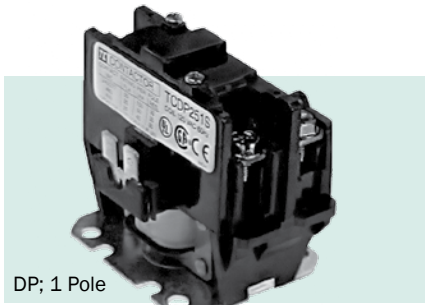

1 Pole (with shunt terminal)

Full Load Amps	Resistive Amps	Catalog No.	Price
25	30	TCDP251S - * 6	\$26.00
30	40	TCDP301S - * 6	\$28.00
40	50	TCDP401S - * 6	\$31.00

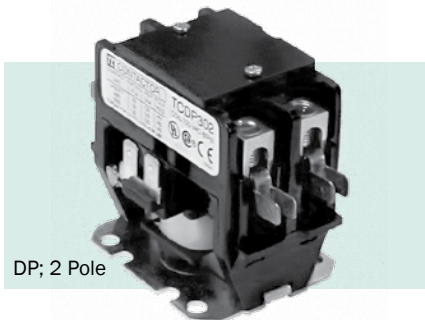

2 Pole

Full Load Amps	Resistive Amps	Catalog No.	Price
20	30	TCDP202 - * 6	\$28.00
30	40	TCDP302 - * 6	\$33.00
40	50	TCDP402 - * 6	\$38.00

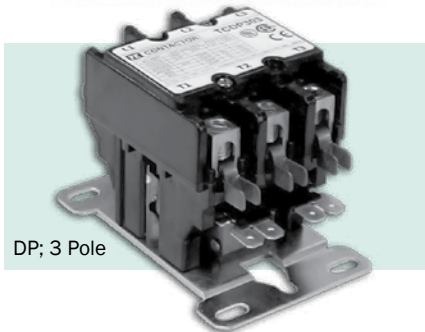

3 Pole

Full Load Amps	Resistive Amps	Catalog No.	Price
25	35	TCDP253 - * 6	\$40.00
30	40	TCDP303 - * 6	\$45.00
40	50	TCDP403 - * 6	\$50.00

*** Coil Voltage**

Volts AC	24	120	208	240	277	480
60 Hz	B	G	L	U	W	T

Discount Schedule SC-40

DIMENSIONS

1 Pole; (Shown)

2 Pole: Shares the same mounting foot and terminal spacing

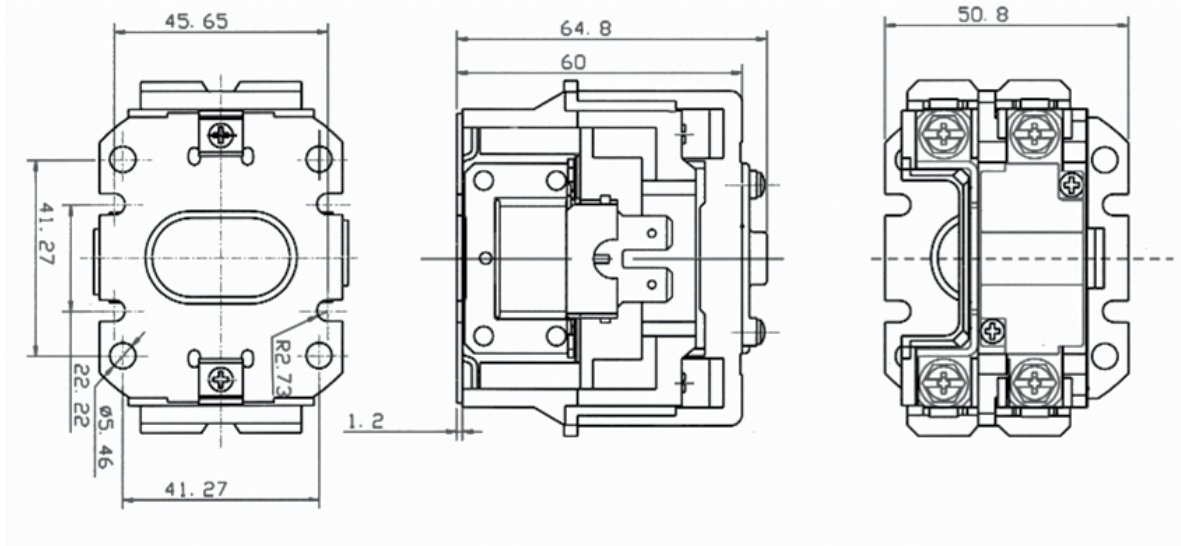

3 Pole; (Shown)

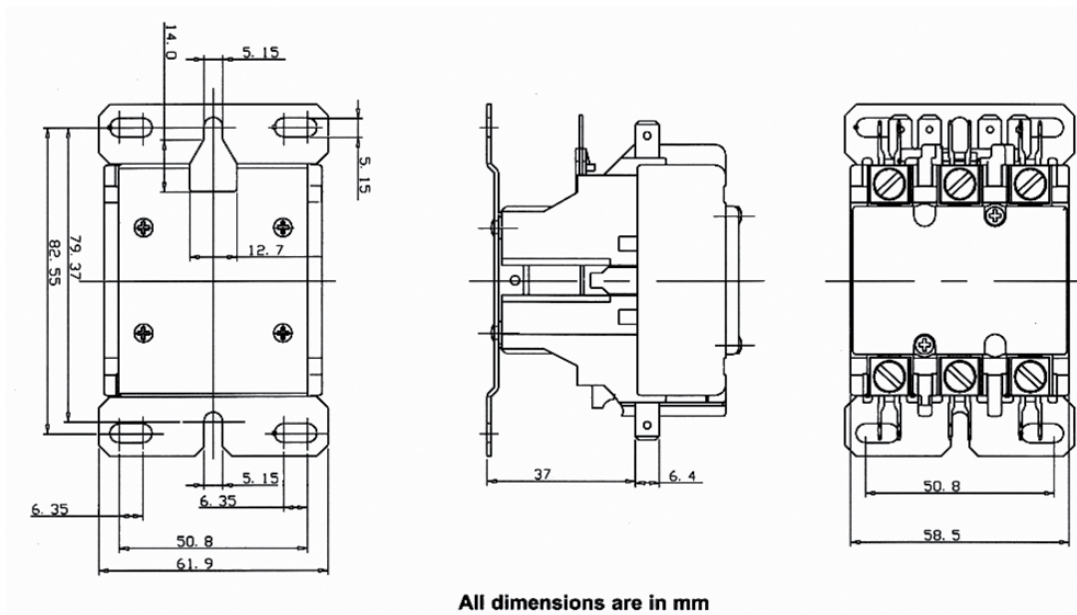

D4

SOLID -STATE CONTACTORS / STARTERS



SPRINGER
controls company

Index
E

Springer Controls Company carries a full line of solid-state contactors manufactured by IC ELECTRONICS A/S. The product line includes single phase electronic contactors, dual contactors, lamp & transformer controls, three phase contactors, soft-starters (1, 2 & 3 phase), reversing contactors, and starting torque limiters. The controllers are also available with internal by-pass as well as with coil controlled external by-pass.

SOLID-STATE CONTACTORS & STARTERS;

Description / Features	E2
Soft Starters	E3
Soft Starters with Dynamic Breaking.....	E4
Starting Torque Limiter - 1-Phase & 3-Phase.....	E4
Electronic Reversing Contactors - 3-Phase.....	E4
Electronic Contactors - 1 Phase	E5
Electronic Analog Controllers.....	E5
1 & 3-Phase Electronic Contactors.....	E6
Contactors for Resistive Heater Application.....	E7, E8
Dimensions	E8

DESCRIPTION / FEATURES

E 2

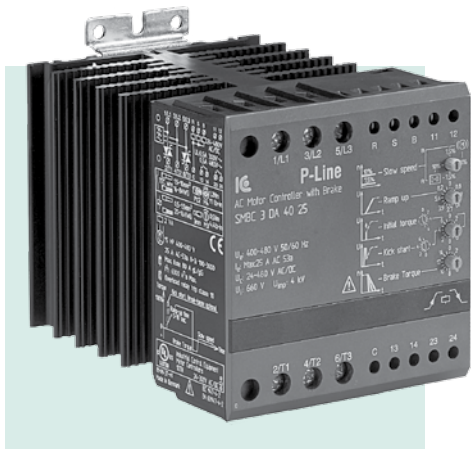

Description

Springer Controls Company carries a full line of solid-state contactors manufactured by IC ELECTRONICS A/S. The product line includes single phase electronic contactors, dual contactors, lamp & transformer controls, three phase contactors, soft-starters (1, 2 & 3 phase), reversing contactors, and starting torque limiters. The controllers are also available with internal by-pass as well as with coil controlled external by-pass.

Springer Controls also carries a full line of solid state overload relays manufactured by FANOX. Consult factory for pricing and availability.

Applications

- Motor Controls
- Mercury Switch Replacement
- Heat Controllers
- Lamp Control
- Extreme Vibration
- High Frequency of Operation

Key Features

- Contactors are UL and CSA certified as well as have the IEC international certification.
- Complete solid state SMT
- Top quality design for electrically harsh industrial applications.
- DIN rail mounting options
- Compact modular design; smallest soft-starter made (22.5 mm).
- Operational Voltage; 24V - 600V AC/DC
- Control Voltage; 24V - 600V AC/DC
- IP - 20 protection



Soft Starters - THREE CONTROLLED PHASES

Control voltage: 24-230/480 VAC/DC. Ramp-Up 0.5-30 sec./Ramp-down time 0.5-60 sec. Initial torque adjustment with 200ms selectable kick start. BP= By-Passing the soft starter with an external mechanical contactor.

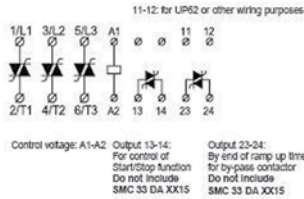

Line voltage 50/60 Hz	Motor Size HP / A without by-pass		Motor Size HP / A with by-pass (BP)		Modul width	Catalog No.	Price
208 - 240VAC	5	15A	---	---	90 mm	SMC 33 DA 2315	\$807.00
400 - 480VAC	10	15A	---	---	90 mm	SMC 33 DA 4015	\$855.00
208 - 240VAC	5	17A	10	25A	90 mm	SMC 33 DA 2325 BP	\$1058.00
400 - 480VAC	10	17A	15	25A	90 mm	SMC 33 DA 4025 BP	\$1191.00
208 - 240VAC	15	35A	20	50A	180 mm	SMC 33 DA 2350 BP	\$1588.00
400 - 480VAC	20	35A	30	50A	180 mm	SMC 33 DA 4050 BP	\$1714.00
550 - 600VAC	30	35A	50	50A	180 mm	SMC 33 DA 6050 BP	\$1856.00

Items for Inside Delta Configuration

208 - 240VAC	10	29A	15	43A	90 mm	SMC 33 DA 2340 DBP	\$1150.00
400 - 480VAC	20	29A	20	43A	90 mm	SMC 33 DA 4040 DBP	\$1295.00
208 - 240VAC	25	60A	30	86A	180 mm	SMC 33 DA 2385 DBP	\$1906.00
400 - 480VAC	40	60A	60	86A	180 mm	SMC 33 DA 4085 DBP	\$2057.00
550 - 600VAC	40	60A	60	86A	180 mm	SMC 33 DA 6085 DBP	\$2227.00

Soft Starters - TWO CONTROLLED PHASES

Control voltage: 24-230/480 VAC/DC. Ramp-Up/Down time 0.5 - 10/20 sec. Initial torque adjustment with 200ms selectable kick start. BP = By-Passing the soft starter with an external mechanical contactor unless tested as internal.

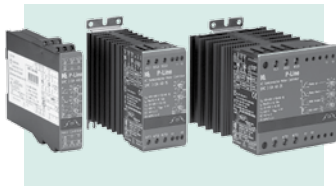

SMC 3 DA XX15/25
11-12: for UP62 or other wiring purposes

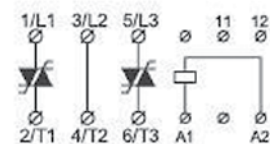

Line voltage 50/60 Hz	Motor Size HP / A without by-pass		Motor Size HP / A with by-pass (BP)		Modul width	Catalog No.	Price
208 - 240VAC	1	3A	Internal by-pass relay		22.5 mm	SMC 3 DA 2303	\$427.00
400 - 415VAC	2	3A	Internal by-pass relay		22.5 mm	SMC 3 DA 4003	\$427.00
440 - 480VAC	2	3A	Internal by-pass relay		22.5 mm	SMC 3 DA 4803	\$453.00
550 - 600VAC	2	3A	Internal by-pass relay		22.5 mm	SMC 3 DA 6003	\$462.00
208 - 240VAC	5	15A	Internal by-pass relay		45 mm	SMC 32 DA 2315 BP	\$587.00
400 - 415VAC	10	15A	Internal by-pass relay		45 mm	SMC 32 DA 4015 BP	\$587.00
440 - 480VAC	10	15A	Internal by-pass relay		45 mm	SMC 32 DA 4815 BP	\$623.00
208 - 240VAC	5	15A			45 mm	SMC 3 DA 2315	\$606.00
400 - 480VAC	10	15A			45 mm	SMC 3 DA 4015	\$635.00
550 - 600VAC	15	15A			45 mm	SMC 3 DA 6015	\$683.00
208 - 240VAC	10	25A			90 mm	SMC 3 DA 2325	\$913.00
400 - 480VAC	15	25A			90 mm	SMC 3 DA 4025	\$952.00
550 - 600VAC	25	25A			90 mm	SMC 3 DA 6025	\$1010.00
208 - 240VAC	10	25A	15	30A	90 mm	SMC 3 DA 2325 BP	\$1013.00
400 - 480VAC	15	25A	20	30A	90 mm	SMC 3 DA 4025 BP	\$1067.00
550 - 600VAC	25	25A	25	30A	90 mm	SMC 3 DA 6025 BP	\$1120.00

Discount Schedule SC-30

TORQUE LIMITERS & REVERSING CONTACTORS

Soft Starters for 3-Phase Motor Application With Integrated Dynamic Brake

Control voltage: 24-230/480 VAC/DC. Ramp-Up/Down time 0.5 - 10 sec. Initial torque adjustment with 200ms selectable kick start. BP = By-Passing the soft starter with an external mechanical contactor.

Brake

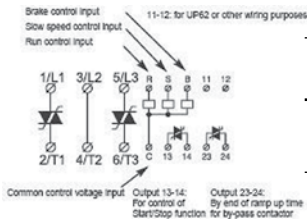

Line voltage 50/60 Hz	Motor Size HP / A without by-pass		Motor Size HP / A with by-pass (BP)		Modul width	Catalog No.	Price
208 - 240VAC	10	25A			90 mm	SMBC 3 DA 2325	\$1795.00
400 - 415VAC	15	25A	20	30A	90 mm	SMBC 3 DA 4025	\$1831.00

Starting Torque Limiter for 3-Phase Motor Applications

Ramp-Up time 0.5 - 5 sec. with initial torque adjustment.

1-controlled phase

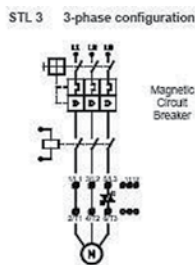

Line voltage 50/60 Hz	Motor Size HP / A without by-pass		Modul width	Catalog No.	Price
120 - 240VAC	5	15A	45 mm	STL 3 1215	\$302.00
208 - 480VAC	10	15A	45 mm	STL 3 4015	\$317.00
550 - 600VAC	10	15A	45 mm	STL 3 6015	\$375.00
120 - 240VAC	2.5	25A	45 mm	STL 3 1225	\$350.00
208 - 480VAC	15	25A	45 mm	STL 3 4025	\$365.00
550 - 600VAC	25	25A	45 mm	STL 3 6025	\$423.00

Starting Torque Limiter for 1-Phase Motor Applications

Ramp-Up time 0.5 - 5 sec. with initial torque adjustment.

1-controlled phase

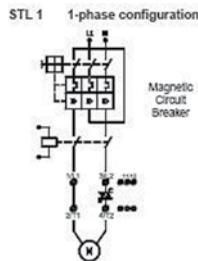

Line voltage 50/60 Hz	Motor Size HP / A without by-pass		Modul width	Catalog No.	Price
120 - 240VAC	3	15A	45 mm	STL 1 1215	\$302.00
208 - 480VAC	5	15A	45 mm	STL 1 4015	\$315.00
550 - 600VAC	5	15A	45 mm	STL 1 6015	\$371.00
120 - 240VAC	5	25A	45 mm	STL 1 1225	\$350.00
208 - 480VAC	10	25A	45 mm	STL 1 4025	\$363.00
550 - 600VAC	10	25A	45 mm	STL 1 6025	\$419.00

Electronic Reversing Contactor for 3-Phase Motor Applications

Reversing

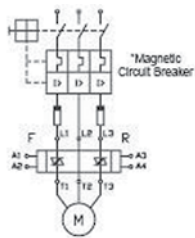

Line voltage 50/60 Hz	Motor Size HP / A		Control Voltage	Modul width	Catalog No.	Price
24 - 480VAC	5	10A	5 - 24VDC	45 mm	SRC 3 DD 4010	\$585.00
24 - 480VAC	5	10A	24-230VAC/DC	45 mm	SRC 3 DA 4010	\$606.00

Electronic Reversing Contactor (DOL) for 3-Phase Motor Applications

Reversing



Line voltage 50/60 Hz	Motor Size HP / A		Control Voltage	Modul width	Catalog No.	Price
208 - 240VAC	5	15A	5 - 60VDC	45 mm	SMC 3 DA 2315 DOL	\$365.00
400 - 480VAC	10	15A	&	45 mm	SMC 3 DA 4015 DOL	\$397.00
550 - 600VAC	15	15A	24 - 480VAC	45 mm	SMC 3 DA 6015 DOL	\$413.00

Discount Schedule SC-30

ONE PHASE ELECTRONIC CONTACTORS

E 5

1-Phase Electronic Contactors

Load 15A / 30A / 50A / 63A

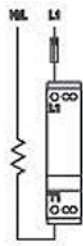

Line voltage 50/60 Hz	Current Load		Control Voltage	Modul width	Catalog No.	Price
	AC-1/51	AC-3/53				
12 - 240VAC	15A	15A	5 - 24VDC	22.5 mm	SC 1 DD 2315	\$169.00
24 - 480VAC	15A	15A	5 - 24VDC	22.5 mm	SC 1 DD 4015	\$189.00
48 - 600VAC	15A	15A	5 - 24VDC	22.5 mm	SC 1 DD 6015	\$238.00
12 - 240VAC	15A	15A	24 - 230VAC/DC	22.5 mm	SC 1 DA 2315	\$198.00
24 - 480VAC	15A	15A	24 - 230VAC/DC	22.5 mm	SC 1 DA 4015	\$217.00
48 - 600VAC	15A	10A	24 - 230VAC/DC	22.5 mm	SC 1 DA 6015	\$266.00
12 - 240VAC	30A	15A	5 - 24VDC	45 mm	SC 1 DD 2330	\$210.00
24 - 480VAC	30A	15A	5 - 24VDC	45 mm	SC 1 DD 4030	\$227.00
48 - 600VAC	30A	15A	5 - 24VDC	45 mm	SC 1 DD 6030	\$278.00
12 - 240VAC	30A	15A	24 - 230VAC/DC	45 mm	SC 1 DA 2330	\$226.00
24 - 480VAC	30A	15A	24 - 230VAC/DC	45 mm	SC 1 DA 4030	\$243.00
48 - 600VAC	30A	15A	24 - 230VAC/DC	45 mm	SC 1 DA 6030	\$300.00
12 - 240VAC	50A	15A	5 - 24VDC	90 mm	SC 1 DD 2350	\$259.00
24 - 480VAC	50A	15A	5 - 24VDC	90 mm	SC 1 DD 4050	\$276.00
48 - 600VAC	50A	15A	5 - 24VDC	90 mm	SC 1 DD 6050	\$279.00
12 - 240VAC	50A	15A	24 - 230VAC/DC	90 mm	SC 1 DA 2350	\$275.00
24 - 480VAC	50A	15A	24 - 230VAC/DC	90 mm	SC 1 DA 4050	\$292.00
48 - 600VAC	50A	15A	24 - 230VAC/DC	90 mm	SC 1 DA 6050	\$313.00
12 - 240VAC	63A	30A	5 - 24VDC	90 mm	SC 1 DD 2363	\$302.00
24 - 480VAC	63A	30A	5 - 24VDC	90 mm	SC 1 DD 4063	\$318.00
48 - 600VAC	63A	30A	5 - 24VDC	90 mm	SC 1 DD 6063	\$356.00
12 - 240VAC	63A	30A	24 - 230VAC/DC	90 mm	SC 1 DA 2363	\$320.00
24 - 480VAC	63A	30A	24 - 230VAC/DC	90 mm	SC 1 DA 4063	\$333.00
48 - 600VAC	63A	30A	24 - 230VAC/DC	90 mm	SC 1 DA 6063	\$373.00

1-Phase Electronic Contactors with Neutral Connection

Load 30A / 50A

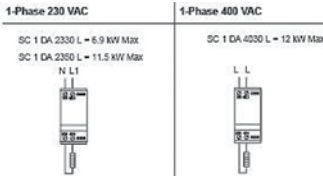

Line voltage 50/60 Hz	Motor Size kW / A		Control Voltage	Modul width	Catalog No.	Price
	AC-1/51	AC-3/53				
110 - 230VAC	30A	15A	24 - 230VAC/DC	45 mm	SC 1 DA 2330 L	\$261.00
380 - 415VAC	30A	15A	24 - 230VAC/DC	45 mm	SC 1 DA 4030 L	\$299.00
110 - 230VAC	50A	15A	24 - 230VAC/DC	90 mm	SC 1 DA 2350 L	\$290.00

1-Phase Electronic Analogue Power Controllers (phase angle or burst firing control mode)

Load 30A / 50A



Line voltage 50/60 Hz	Current Load		Control Signal	Modul width	Catalog No.	Price
	AC-1/51	AC-3/53				
208 - 240VAC	30A	30A	0-20mA/20-0mA	45 mm	SPC 1 AD 2330	\$596.00
208 - 240VAC	50A	30A	4-20mA/20-4mA	90 mm	SPC 1 AD 2350	\$660.00
380 - 480VAC	30A	30A	0-10volt/10-0volt	45 mm	SPC 1 AD 4030	\$617.00
380 - 480VAC	50A	30A	0-10kohm/10-0kohm	90 mm	SPC 1 AD 4050	\$682.00

Discount Schedule SC-30

ONE & THREE-PHASE ELECTRONIC CONTACTORS

1-Phase Dual Pole Electronic Contactors (accumulated, two independent controlled phases)

E 6

Load 30A / 50A accumulated

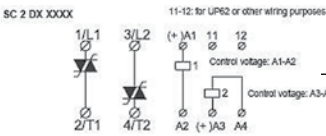

Line voltage 50/60 Hz	Current Load		Control Voltage	Modul width	Catalog No.	Price
	AC-1/51	AC-3/53				
12 - 240VAC	30A acc	15A acc	5 - 24VDC	45 mm	SC 2 DD 2330	\$303.00
24 - 480VAC	30A acc	15A acc	5 - 24VDC	45 mm	SC 2 DD 4030	\$337.00
48 - 600VAC	30A acc	15A acc	5 - 24VDC	45 mm	SC 2 DD 6030	\$365.00
12 - 240VAC	30A acc	15A acc	24 - 230VAC/DC	45 mm	SC 2 DA 2330	\$342.00
24 - 480VAC	30A acc	15A acc	24 - 230VAC/DC	45 mm	SC 2 DA 4030	\$377.00
48 - 600VAC	30A acc	15A acc	24 - 230VAC/DC	45 mm	SC 2 DA 6030	\$401.00
12 - 240VAC	50A acc	15A acc	5 - 24VDC	90 mm	SC 2 DD 2350	\$352.00
24 - 480VAC	50A acc	15A acc	5 - 24VDC	90 mm	SC 2 DD 4050	\$387.00
48 - 600VAC	50A acc	15A acc	5 - 24VDC	90 mm	SC 2 DD 6050	\$409.00
12 - 240VAC	50A acc	15A acc	24 - 230VAC/DC	90 mm	SC 2 DA 2350	\$392.00
24 - 480VAC	50A acc	15A acc	24 - 230VAC/DC	90 mm	SC 2 DA 4050	\$426.00
48 - 600VAC	50A acc	15A acc	24 - 230VAC/DC	90 mm	SC 2 DA 6050	\$445.00

3-Phase Electronic Contactors (three controlled phases)

Load 10A / 20A

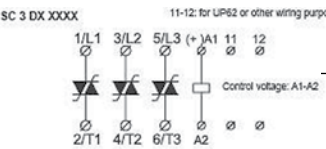

Line voltage 50/60 Hz	Current Load		Control Voltage	Modul width	Catalog No.	Price
	AC-1/51	AC-3/53				
12 - 240VAC	10A	10A	5 - 24VDC	45 mm	SC 3 DD 2310	\$330.00
24 - 480VAC	10A	10A	5 - 24VDC	45 mm	SC 3 DD 4010	\$382.00
48 - 600VAC	10A	10A	5 - 24VDC	45 mm	SC 3 DD 6010	\$437.00
12 - 240VAC	10A	10A	24 - 230VAC/DC	45 mm	SC 3 DA 2310	\$344.00
24 - 480VAC	10A	10A	24 - 230VAC/DC	45 mm	SC 3 DA 4010	\$382.00
48 - 600VAC	10A	10A	24 - 230VAC/DC	45 mm	SC 3 DA 6010	\$450.00
12 - 240VAC	20A	10A	5 - 24VDC	90 mm	SC 3 DD 2320	\$379.00
24 - 480VAC	20A	10A	5 - 24VDC	90 mm	SC 3 DD 4020	\$431.00
48 - 600VAC	20A	10A	5 - 24VDC	90 mm	SC 3 DD 6020	\$481.00
12 - 240VAC	20A	10A	24 - 230VAC/DC	90 mm	SC 3 DA 2320	\$393.00
24 - 480VAC	20A	10A	24 - 230VAC/DC	90 mm	SC 3 DA 4020	\$446.00
48 - 600VAC	20A	10A	24 - 230VAC/DC	90 mm	SC 3 DA 6020	\$493.00

AC Auxiliary Contact Module

Load 5A



Line voltage 50/60 Hz	Current Load		Control Voltage	Modul width	Catalog No.	Price
	AC-22	DC-22				
208 - 600VAC	5A	3A	208 - 600VAC	22.5 mm	MAUX 01 600	\$173.00

Discount Schedule SC-30

CONTACTORS FOR RESISTIVE HEATER APPLICATION

E7

1-Pole Contactors



Line Voltage	Load	Control Voltage	Catalog No.	Price
Electronic Contactor 1-pole 10A 230V				
230 VAC	10A	5 - 24 VDC	RC11DD2310	\$449.00
Electronic Contactor 1-pole 15A 230V				
230 VAC	15A	5 - 24 VDC	RC11DD2315	\$521.00
230 VAC	15A	24 - 230 VAC/DC	RC11DA2315	\$590.00
Electronic Contactor 1-pole 15A 400V				
400VAC	15A	5 - 24 VDC	RC11DD4015	\$535.00
400 VAC	15A	24 - 230 VAC/DC	RC11DA4015	\$625.00
Electronic Contactor 1-pole 30A 230V				
230 VAC	30A	5 - 24 VDC	RC11DD2330	\$611.00
230 VAC	30A	24 - 230 VAC/DC	RC11DA2330	\$666.00
Electronic Contactor 1-pole 50A 230V				
230 VAC	50A	5 - 24 VDC	RC11DD2350	\$784.00
230 VAC	50A	24 - 230 VAC/DC	RC11DA2350	\$881.00
Electronic Contactor 1-pole 30A 400V				
400 VAC	30A	5 - 24 VDC	RC11DD4030	\$625.00
400 VAC	30A	24 - 230 VAC/DC	RC11DA4030	\$680.00
Electronic Contactor 1-pole 50A 400V				
400 VAC	50A	5 - 24 VDC	RC11DD4050	\$798.00
400 VAC	50A	24 - 230 VAC/DC	RC11DA4050	\$867.00

2-Pole Contactors

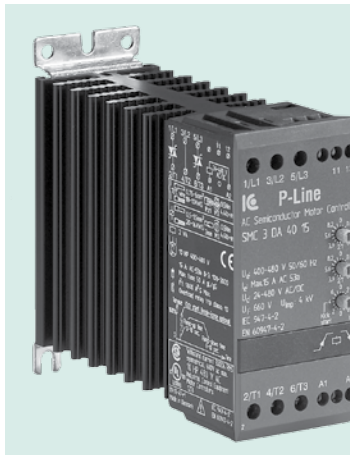

Line Voltage	Load	Control Voltage	Catalog No.	Price
Electronic Contactor 2-pole 30A 230V				
230 VAC	30A	5 - 24 VDC	RC22DD2330	\$863.00
230 VAC	30A	24 - 230 VAC/DC	RC22DA2330	\$998.00
Electronic Contactor 2-pole 50A 230V				
230 VAC	50A	5 - 24 VDC	RC22DD2350	\$1,105.00
230 VAC	50A	24 - 230 VAC/DC	RC22DA2350	\$1,243.00
Electronic Contactor 2-pole 30A 400V				
400 VAC	30A	5 - 24 VDC	RC22DD4030	\$943.00
400 VAC	30A	24 - 230 VAC/DC	RC22DA4030	\$1,032.00
Electronic Contactor 5-pole 50A 400V				
400 VAC	50A	5 - 24 VDC	RC22DD4050	\$1,122.00
400 VAC	50A	24 - 230 VAC/DC	RC22DA4050	\$1,260.00

Discount Schedule SC-30

CONTACTORS FOR RESISTIVE HEAT APPLICATION

3-Pole Contactors -- 2 Phases Controlled



Line Voltage	Load	Control Voltage	Catalog No.	Price
Electronic Contactor 3-pole 15A 400V				
400 VAC	15A	5 - 24 VDC	RC32DD4015	\$881.00
400 VAC	15A	24 - 230 VAC/DC	RC32DA4015	\$932.00
Electronic Contactor 3-pole 25A 400V				
400 VAC	25A	5 - 24 VDC	RC32DD4025	\$1,019.00
400 VAC	25A	24 - 230 VAC/DC	RC32DA4025	\$1,053.00

3-Pole Contactors -- 3 Phases Controlled

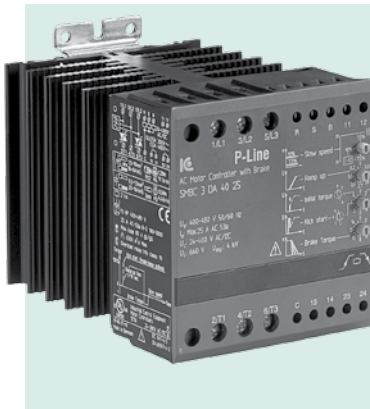

Line Voltage	Load	Control Voltage	Catalog No.	Price
Electronic Contactor 3-pole 10A 230V				
230 VAC	10A	5 - 24 VDC	RC33DD2310	\$1,015.00
230 VAC	10A	24 - 230 VAC/DC	RC33DA2310	\$1,064.00
Electronic Contactor 3-pole 20A 230V				
230 VAC	20A	5 - 24 VDC	RC33DD2320	\$1,160.00
230 VAC	20A	24 - 230 VAC/DC	RC33DA2320	\$1,205.00
Electronic Contactor 3-pole 10A 400V				
400 VAC	10A	5 - 24 VDC	RC33DD4010	\$1,043.00
400 VAC	10A	24 - 230 VAC/DC	RC33DA4010	\$1,095.00
Electronic Contactor 3-pole 20A 400V				
400 VAC	20A	5 - 24 VDC	RC33DD4020	\$1,188.00
400 VAC	20A	24 - 230 VAC/DC	RC33DA4020	\$1,240.00

Dimensions

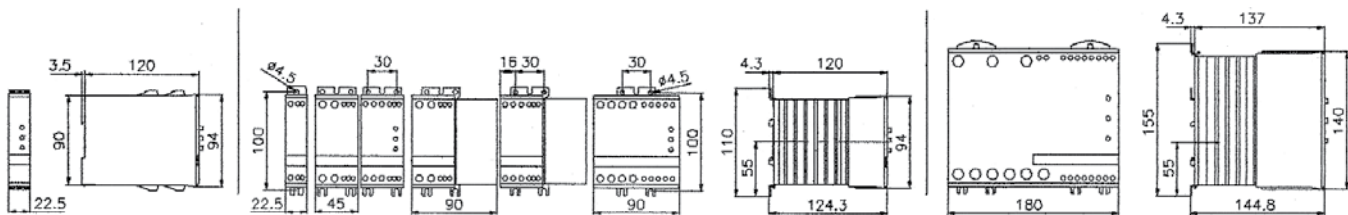

Discount Schedule SC-30

IEC ENGINEERED PRODUCTS



SPRINGER
controls company

Index

F

Springer Controls is a UL approved 508a panel manufacturer. We specialize in direct on-line IEC enclosed AC starters. We can custom make panels to customers specifications. **Springer Controls** also manufactures combination starters, reversing starters as well as Wye-Delta starters.

ENGINEERED PRODUCTS;

IEC Enclosed Non-reversing Starters	F2
IEC Enclosed Reversing Starters.....	F3
IEC Enclosed Combination Starters.....	F4
IEC Wye Delta Starters.....	F5
Modifications.....	F6
IEC Enclosure Classification (IP Ratings).....	F7
Horsepower Motor Ratings.....	F8
Kilowatt Motor Ratings.....	F9
Electrical Formulas.....	F10

ENCLOSED NON-REVERSING STARTERS

Springer Controls is a UL approved 508a panel manufacturer. We specialize in direct on-line IEC enclosed AC starters. We can custom make panels to customers specifications. **Springer Controls** also manufactures combination starters, reversing starters, as well as Wye-Delta starters.

Enclosed Non-Reversing Starters

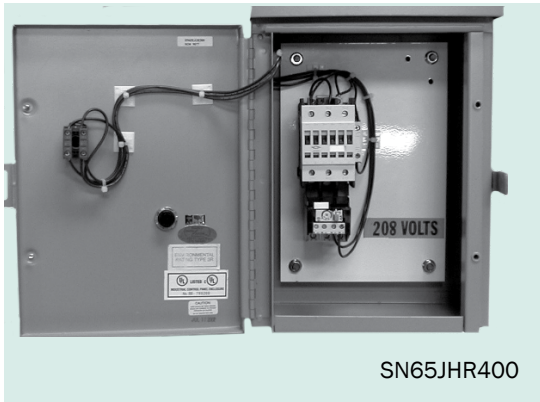

Example: #**SN65JHR400**

- 40 hp 460 Volts
- 120V Control Power
- Overload Relay Protection (54-65 amps)
- Nema 3R Rated Enclosure (16" x 12" x 8")
- Start / Stop Control Buttons on Cover

F 2

Enclosed Non-Reversing Starters

CPT **not** included on starters below 60 HP at 460V

• 120V Control Power

• Start/Stop (Internal Reset)

*Select overload letter from chart on the bottom of this page.

Maximum Motor HP			Nema 1 (metal)		Nema 3R (metal)		Nema 12 (metal)		N1,3,4X, 12 (poly)	
200VAC	230VAC	460VAC	Catalog No.	Price	Catalog No.	Price	Catalog No.	Price	Catalog No.	Price
3	3	5	SN09J*A400	\$299.00	SN09J*R400	\$394.00	SN09J*T400	\$467.00	JC0906P1G-J*	\$299.00
3	3	7.5	SN12J*A400	\$382.00	SN12J*R400	\$462.00	SN09J*T400	\$506.00	JC1206P1G-J*	\$339.00
5	4	10	SN18J*A400	\$406.00	SN18J*R400	\$494.00	SN12J*T400	\$530.00	JC1806P1G-J*	\$363.00
7.5	7.5	15	SN25J*A400	\$426.00	SN25J*R400	\$510.00	SN18J*T400	\$565.00	JC2506P1B-J*	\$419.00
10	10	20	SN32J*A400	\$486.00	SN32J*R400	\$550.00	SN25J*T400	\$616.00	JC3206P1B-J*	\$470.00
15	15	30	SN50J*A400	\$680.00	SN50J*R400	\$744.00	SN32J*T400	\$798.00	JC5006P1K-J*	\$755.00
20	20	40	SN65J*A400	\$752.00	SN65J*R400	\$816.00	SN50J*T400	\$892.00	JC6506P1K-J*	\$784.00
20	25	50	SN80J*A400	\$930.00	SN80J*R400	\$994.00	SN65J*T400	\$1022.00	JC8006P1K-J*	\$891.00
25	30	60	SN95J*A402	\$1,267.00	SN95J*R402	\$1,410.00	SN80J*T400	\$1,480.00	SN95J*P402	C.F.
30	40	75	SNC5J*A402	\$1,475.00	SNC5J*R402	\$1,629.00	SN95J*T402	\$1,629.00	SNC5J*P402	C.F.
40	50	100	SNC5J*A402	\$2,107.00	SNC5J*R402	\$2,267.00	SNC5J*T402	\$2,267.00	SNC5J*P402	C.F.
50	50	125	SN150J*A402	\$2,864.00	SN150J*R402	\$3,184.00	SNC5J*T402	\$3,184.00	SN105J*P402	C.F.
50	60	150	SN185J*A402	\$3,128.00	SN185J*R402	\$3,448.00	SN150J*T402	\$3,448.00	SN185J*P402	C.F.
60	75	200	SN250J*A402	\$4,384.00	SN250J*R402	\$4,704.00	SN185J*T402	\$4,704.00	SN250J*P402	C.F.
100	100	250	SN309J*A402	\$4,704.00	SN309J*R402	\$4,904.00	SN250J*T402	\$4,904.00	SN309J*P402	C.F.

Overload Current	Mdl. Letter	Overload Current	Mdl. Letter
4.0 - 6.3 Amp	L	42.0 - 55.0 Amp	G
5.5 - 8.5 Amp	M	54.0 - 65.0 Amp	H
8.0 - 12.0 Amp	N	64.0 - 82.0 Amp	J
10.0 - 16.0 Amp	P	78.0 - 97.0 Amp	L
14.5 - 18.0 Amp	S	90.0 - 110 Amp	M
17.5 - 22.0 Amp	T	110 - 140 Amp	E
21.0 - 26.0 Amp	U	140 - 190 Amp	F
25.0 - 32.0 Amp	V	175 - 280 Amp	P
30.0 - 40.0 Amp	W	200 - 310 Amp	R

Discount Schedule SC-70

ENCLOSED REVERSING STARTERS

F 3

Enclosed Reversing Starters

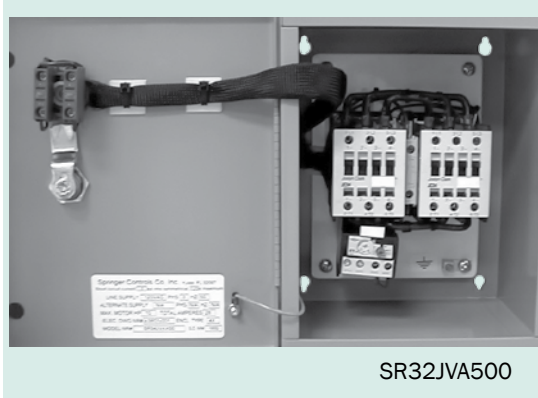

Example: #**SR32JVA500**

- 20 hp 460 Volts
- 120V Control Power
- Mechanical Interlock
- Overload Relay Protection (25 - 32 Amps)
- Nema 1 Rated Enclosure (10" x 8" x 6")
- REV-OFF-FWD Cover Controls

Enclosed Reversing Starters with overload protection

CPT **not** included on starters below 60 HP at 460V

• 120V Control Power

• Forward-Off-Reverse

*Select overload letter from chart on the bottom of this page.

Maximum Motor HP			Nema 1 (metal)		Nema 3R (metal)		Nema 12 (metal)		N1,3,4X, 12 (poly)	
200VAC	230VAC	460VAC	Catalog No.	Price	Catalog No.	Price	Catalog No.	Price	Catalog No.	Price
3	3	5	SR09J*A500	\$691.00	SR09J*R500	\$787.00	SR09J*T500	\$934.00	SR09J*P500	\$691.00
3	3	7.5	SR12J*A500	\$765.00	SR12J*R500	\$925.00	SR12J*T500	\$1,011.00	SR12J*P500	\$765.00
5	5	10	SR18J*A500	\$813.00	SR18J*R500	\$989.00	SR18J*T500	\$1,059.00	SR18J*P500	\$813.00
7.5	7.5	15	SR25J*A500	\$851.00	SR25J*R500	\$1,021.00	SR25J*T500	\$1,130.00	SR25J*P500	\$851.00
10	10	20	SR32J*A500	\$1,008.00	SR32J*R500	\$1,101.00	SR32J*T500	\$1,232.00	SR32J*P500	\$1,008.00
15	15	30	SR50J*A500	\$1,360.00	SR50J*R500	\$1,488.00	SR50J*T500	\$1,597.00	SR50J*P500	C.F.
20	20	40	SR65J*A500	\$1,504.00	SR65J*R500	\$1,632.00	SR65J*T500	\$1,786.00	SR65J*P500	C.F.
20	25	50	SR80J*A500	\$1,699.00	SR80J*R500	\$1,987.00	SR80J*T500	\$2,045.00	SR80J*P500	C.F.
25	30	60	SR95J*A502	\$2,534.00	SR95J*R502	\$2,819.00	SR95J*T502	\$2,960.00	SR95J*P402	C.F.
30	40	75	SRC5J*A502	\$2,950.00	SRC5J*R502	\$3,258.00	SRC5J*T502	\$3,258.00	SRC5J*P402	C.F.
40	50	100	SRC5J*A502	\$4,214.00	SRC5J*R502	\$4,534.00	SRC5J*T502	\$6,134.00	SRC5J*P402	C.F.
50	50	125	SR150J*A502	\$5,728.00	SR150J*R502	\$6,368.00	SR150J*T502	\$6,368.00	SR150J*P402	C.F.
50	60	150	SR185J*A502	\$6,256.00	SR185J*R502	\$6,896.00	SR185J*T502	\$6,896.00	SR185J*P402	C.F.
60	75	200	SR250J*A502	\$8,768.00	SR250J*R502	\$9,408.00	SR250J*T502	\$9,408.00	SR250J*P402	C.F.
100	100	250	SR309J*A502	\$9,408.00	SR309J*R502	\$9,808.00	SR309J*T502	\$9,808.00	SR309J*P402	C.F.

Consult factory for CPT and larger enclosure

Overload Current	Mdl. Letter	Overload Current	Mdl. Letter
4.0 - 6.3 Amp	L	42.0 - 55.0 Amp	G
5.5 - 8.5 Amp	M	54.0 - 65.0 Amp	H
8.0 - 12.0 Amp	N	64.0 - 82.0 Amp	J
10.0 - 16.0 Amp	P	78.0 - 97.0 Amp	L
14.5 - 18.0 Amp	S	90.0 - 110 Amp	M
17.5 - 22.0 Amp	T	110 - 140 Amp	E
21.0 - 26.0 Amp	U	140 - 190 Amp	F
25.0 - 32.0 Amp	V	175 - 280 Amp	P
30.0 - 40.0 Amp	W	200 - 310 Amp	R

Discount Schedule SC-70

ENCLOSED COMBINATION STARTERS; NON-FUSIBLE & FUSIBLE

Enclosed Non-Reversing Starters



Example: #SCNN09JMP400

- 9 amp contactor with overload protection
- Main power disconnect switch
- Start-Stop cover controls
- Polycarbonate N4X enclosure

F 4

Combination Non-Reversing Starters - NON-FUSIBLE

CPT **not** included on starters below 60 HP at 460V

• 120V Control Power

• Start/Stop

*Select overload letter from chart on the bottom of this page.

Maximum Motor HP			Neme 1 (metal)		Nema 3R (metal)		Nema 12 (metal)		N1,3,4X, 12 (poly)	
200VAC	230VAC	460VAC	Catalog No.	Price	Catalog No.	Price	Catalog No.	Price	Catalog No.	Price
3	3	5	SCNN09J*A400	\$880.00	SCNN09J*R400	\$912.00	SCNN09J*T400	\$1,003.00	SCNN09J*P400	\$1,144.00
3	3	7.5	SCNN12J*A400	\$912.00	SCNN12J*R400	\$944.00	SCNN12J*T400	\$1,035.00	SCNN12J*P400	\$1,176.00
5	5	10	SCNN18J*A400	\$944.00	SCNN18J*R400	\$976.00	SCNN18J*T400	\$1,051.00	SCNN18J*P400	\$1,192.00
5	7.5	15	SCNN25J*A400	\$1,032.00	SCNN25J*R400	\$1,157.00	SCNN25J*T400	\$1,203.00	SCNN25J*P400	\$1,275.00
10	10	20	SCNN32J*A400	\$1,120.00	SCNN32J*R400	\$1,277.00	SCNN32J*T400	\$1,291.00	SCNN32J*P400	\$1,363.00
15	15	30	SCNN50J*A400	\$1,232.00	SCNN50J*R400	\$1,379.00	SCNN50J*T400	\$1,774.00	SCNN50J*P400	\$1,398.00
20	20	40	SCNN65J*A400	\$1,760.00	SCNN65J*R400	\$1,907.00	SCNN65H*T400	\$2,302.00	SCNN65J*P400	\$1,926.00
20	25	50	SCNN80J*A400	\$2,000.00	SCNN80J*R400	\$2,147.00	SCNN80J*T400	\$2,542.00	SCNN80J*P400	\$2,166.00
25	30	60	SCNN95J*A402	\$2,448.00	SCNN95J*R402	\$2,448.00	SCNN95J*T402	\$2,811.00	SCNN95J*P402	C.F.
30	40	75	SCNNC5J*A402	\$3,056.00	SCNNC5J*R402	\$3,056.00	SCNNC5J*T402	\$3,419.00	SCNNC5J*P402	C.F.

CPT Fuses for both primary and secondary are included

Combination Non-Reversing Starters - FUSIBLE

CPT **not** included on starters below 60 HP at 460V

• 120V Control Power

• Start/Stop

*Select overload letter from chart on the bottom of this page.

Maximum Motor HP			Neme 1 (metal)		Nema 3R (metal)		Nema 12 (metal)		N1,3,4X, 12 (poly)	
200VAC	230VAC	460VAC	Catalog No.	Price	Catalog No.	Price	Catalog No.	Price	Catalog No.	Price
3	3	5	SCNF09J*3A400	\$944.00	SCNF09J*3R400	\$1,090.00	SCNF09J*3T400	\$1,240.00	SCNF09J*3P400	\$1,208.00
3	3	7.5	SCNF12J*3A400	\$980.00	SCNF12J*3R400	\$1,132.00	SCNF12J*3T400	\$1,320.00	SCNF12J*3P400	\$1,228.00
3	5	10	SCNF18J*3A400	\$1,040.00	SCNF18J*3R400	\$1,215.00	SCNF18J*3T400	\$1,359.00	SCNF18J*3P400	\$1,248.00
5	7.5	15	SCNF25J*3A400	\$1,223.00	SCNF25J*3R400	\$1,336.00	SCNF25J*3T400	\$1,448.00	SCNF25J*3P400	\$1,356.00
10	10	20	SCNF32J*6A400	\$1,360.00	SCNF32J*6R400	\$1,501.00	SCNF32J*6T400	\$1,645.00	SCNF32J*6P400	\$1,645.00
15	15	30	SCNF50J*6A400	\$1,589.00	SCNF50J*6R400	\$1,754.00	SCNF50J*6T400	\$1,925.00	SCNF50J*6P400	C.F.
20	20	40	SCNF65J*1A400	\$2,144.00	SCNF65J*1R400	\$2,515.00	SCNF65J*1T400	\$2,923.00	SCNF65J*1P400	C.F.
20	25	50	SCNF80J*1A400	\$2,176.00	SCNF80J*1R400	\$2,554.00	SCNF80J*T400	\$2,943.00	SCNF80J*1P400	C.F.
25	30	60	SCNF95J*1A402	\$2,672.00	SCNF95J*1R402	\$3,003.00	SCNF95J*1T402	\$3,437.00	SCNF95J*1P402	C.F.
30	40	75	SCNFC5J*2A402	\$3,376.00	SCNFC5J*2R402	\$3,376.00	SCNFC5J*2T402	\$3,659.00	SCNFC5J*2P402	C.F.

CPT Fuses for both primary and secondary are included

Overload Current	Mdl. Letter	Overload Current	Mdl. Letter
4.0 - 6.3 Amp	L	42.0 - 55.0 Amp	G
5.5 - 8.5 Amp	M	54.0 - 65.0 Amp	H
8.0 - 12.0 Amp	N	64.0 - 82.0 Amp	J
10.0 - 16.0 Amp	P	78.0 - 97.0 Amp	L
14.5 - 18.0 Amp	S	90.0 - 110 Amp	M
17.5 - 22.0 Amp	T	110 - 140 Amp	E
21.0 - 26.0 Amp	U	140 - 190 Amp	F
25.0 - 32.0 Amp	V	175 - 280 Amp	P
30.0 - 40.0 Amp	W	200 - 310 Amp	R

Description	Price
CPT Adder	\$228.00

Fuses for power circuit NOT included.

Discount Schedule SC-70

ENCLOSED WYE-DELTA STARTERS

Enclosed Starters, Wye-Delta , Open Transition, Non-Reversing - CPT included

- 120V Control Power
- Start/Stop (Internal Reset)
- *Select overload letter from chart below

Maximum Motor HP			Nema 1 (metal)		Nema 3R (metal)		Nema 12 (metal)	
200VAC	230VAC	460VAC	Catalog No.	Price	Catalog No.	Price	Catalog No.	Price
15	20	40	SY32J*A402	\$2,348.00	SY32J*R402	\$2,461.00	SY32J*T402	\$2,461.00
25	30	60	SY50J*A402	\$2,820.00	SY50J*R402	\$3,012.00	SY50J*T402	\$3,012.00
30	40	75	SY65J*A402	\$3,016.00	SY65J*R402	\$3,208.00	SY65J*T402	\$3,208.00
40	50	100	SY95J*A402	\$3,554.00	SY95J*R402	\$3,728.00	SY95J*T402	\$3,728.00
60	60	125	SYC5J*A402	\$4,072.00	SYC5J*R402	\$4,264.00	SYC5J*T402	\$4,264.00
75	75	150	SY150J*A402	\$7,152.00	SY150J*R402	\$7,853.00	SY150J*T402	\$7,853.00
75	100	200	SY185J*A402	\$8,245.00	SY185J*R402	\$8,949.00	SY185J*T402	\$8,949.00
100	125	250	SY250J*A402	\$9,974.00	SY250J*R402	\$10,597.00	SY250J*T402	\$10,597.00

Overload Current	Mdl Letter	Overload Current	Mdl Letter
30.0 - 40.0 Amp	W	90.0 - 110 Amp	M
42.0 - 55.0 Amp	G	110 - 140 Amp	E
54.0 - 65.0 Amp	H	140 - 190 Amp	F
64.0 - 82.0 Amp	J	175 - 280 Amp	P
78.0 - 97.0 Amp	L	200 - 310 Amp	R

Motor FLA x .58 = O/L Amps.

F5

Circuit Diagrams for Reduced Voltage Starters - Wye-Delta

Wye-Delta, open transition

The wye-delta open transition starter starts the motor by closing the S and 1M contactors which energize the windings in wye. The inrush current in wye is reduced to 33% of what it would be if the motor was started with an across the line starter.

The starting time in wye is adjustable with a timer. After the elapsed time of 10 seconds, the S contactor opens which closes the 2M contactor; there is a short period (about 50ms) when the motor is not energized; and then the motor runs full voltage in delta.

A wye-delta starter requires a wye-delta wound motor with all six leads terminated outside the motor housing.

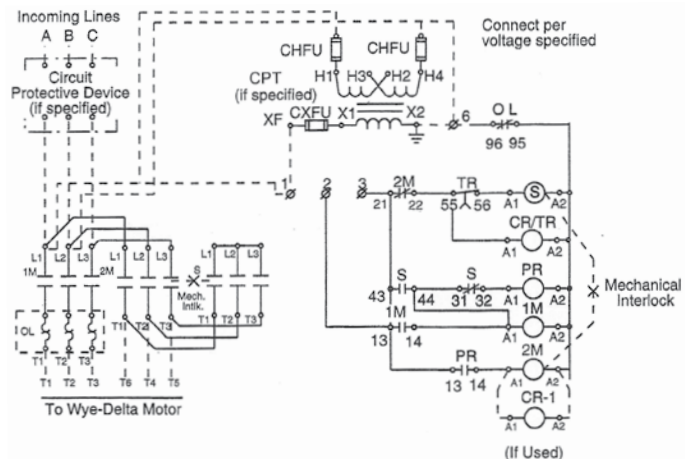

Legend:

CPT	-Control power Transformer	TR	-Timing Relay
CHFU	-Primary Fuse	1M	-First Contactor
CXFU	-Secondary Fuse	2M	-Second Main Contactor
XF	-Control Power Connection Point	S	-Shorting Contactor
CR, CR1	-Control Relays	OL	-Overload Relay
PR	-Pilot Relay		

Discount Schedule SC-70

MODIFICATIONS

F 6

VOLTAGE	Old Code	New Code
24 VAC	-1	1
48 VAC	-9	9
120 VAC	J	4
208 VAC	L	L
240 VAC	S	7
277 VAC	N	N
480 VAC	U	15
600 VAC	Y	Y

DC VOLTAGE		
12 VDC	B	B
24 VDC	D	D
48 VDC	G	G
125 VDC	K	K
250 VDC	T	T

Cover Control

Modification Adders	Code	Price
No Cover Controls	0	(\$50.00)
Reset Only	1	(\$30.00)
HOA + Reset	2	\$48.00
Start/Stop + Reset	3	\$48.00
Start/Stop	4	No charge
HOA only	5	No charge
HOA + Start/Stop	6	\$80.00
2 pos. sel sw	7	No charge
2 pos sel sw + Reset	8	\$48.00

Pilot Lights	Code	Price
None	0	No charge
Amber	A	\$64.00
Blue	B	
Green	G	
Red	R	
White	W	

CPT Designation	Code	Price 50VA	Price 100VA	Price 200VA
None	0	No charge	\$160.00	\$320.00
2540pri - 120 sec	1			
480/240pri - 120 sec	2			
240/120pri - 24 SEC	3			
480/240pri - 24 SEC	4			
480/240/208pri - 120/24 sec	5			

Discount Schedule SC-70

IEC ENCLOSURE CLASSIFICATION

The degree of protection is indicated by two letters (IP) and two numerals. International Standards IEC 529 contains descriptions and associated test requirements that define the degree of protection each numeral specifies. The following table indicates the general degree of protection. For complete test requirements refer to IEC 529.

Example; IP65 ; Dust tight enclosure and protection against water jets.

First Numeral <i>Protection of persons against hazardous parts and protection against penetration of solid foreign objects.</i>	Second Numeral <i>Protection against ingress of water under test conditions specified in IEC 529.</i>
0 Non-protected	0 Non-protected
1 Back of hand; objects greater than 50mm in diameter	1 Vertically falling drops of water
2 Finger; objects greater than 12.5mm in diameter	2 Vertically falling drops of water with enclosure tilted 15 degrees
3 Tools or objects greater than 1.0mm in diameter	3 Spraying water
4 Tools or objects greater than 1.0mm in diameter	4 Splashing water
5 Dust-protected (dust may enter during specified test but must not interfere with operation of the equipment or impair safety)	5 Water jets
6 Dust tight (no dust observable inside enclosure at end of test)	6 Powerful water jets
	7 Temporary submersion
	8 Continuous submersion

F 7

Note:

All first numerals and second numbers up to and including characteristic numerals 6, imply compliance also with the requirements for all lower characteristic numerals in their respective series (first or second).

Second numerals 7 and 8 do not imply suitability for exposure to water jets (second characteristic numeral 5 or 6) unless dual coded; e.g., IP_1/IP_7.

HORSEPOWER MOTOR RATINGS

Full-Load Motor-Running Currents in Amperes
Corresponding to Various A.C. Horsepower Motor Ratings

H.P.	110V - 120V		220V - 240V		380V - 415V		440V - 480V		550V - 600V		2.3 KV	4.16 KC
	Single Phase	Three Phase	Single Phase	Three Phase	Single Phase	Three Phase	Single Phase	Three Phase	Single Phase	Three Phase	Three Phase	Three Phase
1/10	3.0	---	1.5	---	---	---	---	---	---	---	---	---
1/8	3.8	---	1.9	---	---	---	---	---	---	---	---	---
1/6	4.4	---	2.2	---	1.4	---	---	---	---	---	---	---
1/4	5.8	---	2.9	---	1.85	---	---	---	---	---	---	---
1/3	7.2	---	3.6	---	2.32	---	---	---	---	---	---	---
1/2	9.8	4.4	4.9	2.2	3.19	1.28	2.5	1.1	2.0	0.9	---	---
3/4	13.8	6.4	6.9	3.2	4.47	1.78	3.5	1.6	2.8	1.3	---	---
1	16.0	8.4	8.0	4.2	5.12	2.30	4.0	2.1	3.2	1.7	---	---
1.5	20.0	12.0	10.0	6.0	6.38	3.32	5.0	3.0	4.0	2.4	---	---
2	24.0	13.6	12.0	6.8	7.66	4.34	6.0	3.4	4.8	2.7	---	---
3	34.0	19.2	17.0	9.6	10.87	6.14	8.5	4.8	6.8	3.9	---	---
5	56.0	30.4	28.0	15.2	17.90	9.71	14.0	7.6	11.2	6.1	---	---
7.5	80.0	44.0	40.0	22.0	26.80	14.00	21.0	11.0	16.0	9.0	---	---
10	100.0	56.0	50.0	28.0	33.2	17.90	26.0	14.0	20.0	11.0	---	---
15	135.0	84.0	68.0	42.0	---	26.80	34.0	21.0	27.0	17.0	---	---
20	---	108.0	88.0	54.0	---	34.50	44.0	27.0	35.0	22.0	---	---
25	---	136.0	110.0	68.0	---	43.50	55.0	34.0	44.0	27.0	---	---
30	---	160.0	136.0	80.0	---	51.20	68.0	40.0	54.0	32.0	---	---
40	---	208.0	176.0	104.0	---	66.50	88.0	52.0	70.0	41.0	---	---
50	---	260.0	216.0	130.0	---	83.10	108.0	65.0	86.0	52.0	---	---
60	---	---	---	154.0	---	103.0	---	77.0	---	62.0	16.	9.
75	---	---	---	192.0	---	128.0	---	96.0	---	77.0	20.	11.
100	---	---	---	248.0	---	165.0	---	124.0	---	99.0	26.	14.3
125	---	---	---	312.0	---	208.0	---	156.0	---	125.0	31.	17.
150	---	---	---	360.0	---	240.0	---	180.0	---	144.0	37.	20.
200	---	---	---	480.0	---	320.0	---	240.0	---	192.0	49.	27.
250	---	---	---	602.0	---	403.0	---	302.0	---	242.0	60.	33.
300	---	---	---	---	---	482.0	---	361.0	---	289.0	72.	40.
350	---	---	---	---	---	560.0	---	414.0	---	336.0	83.	46.
400	---	---	---	---	---	636.0	---	477.0	---	382.0	95.	52.
500	---	---	---	---	---	786.0	---	590.0	---	472.0	118.	65.

Notes:

1. To obtain F.L.C. for 200 and 208 volt motors multiply 230 volts values by 1.15 and 1.10 respectively.
2. To obtain F.L.C. for 265 and 277 volt motors multiply 230 volts values by .87 and .83 respectively.

KILOWAT MOTOR RATINGS

Kilowatt Motor Ratings

The table below provides the average full-load currents of squirrel cage motors in accordance with IEC conventions. These are given only as a guide. Refer to the actual motor nameplate for full-load current values

Power Kilowatts	Single-Phase Motor		Three-Phase Motor					
	120V	240V	230V	400V	415V	440V	500V	690V
	A	A	A	A	A	A	A	A
0.37	3.9	3.6	2	.98	---	0.99	1	---
0.55	5.2	4.8	2.8	1.5	---	1.36	1.21	---
0.75	6.6	6.1	3.6	1.9	2	1.68	1.5	---
1.1	9.6	8.8	5.2	2.5	2.5	2.37	2	---
1.5	12.7	11.7	6.8	3.4	3.5	3.06	2.6	---
1.8	15.7	14.4	---	---	---	---	---	---
2.2	18.6	17.1	9.6	4.8	5	4.42	3.8	---
3	24.3	22.2	---	6.3	6.5	5.77	5	3.5
3.7	---	---	15.2	---	---	---	---	---
4	29.6	27.1	---	8.1	8.4	7.9	6.5	4.9
4.4	34.7	31.8	---	---	---	---	---	---
5.2	39.8	36.5	---	---	---	---	---	---
5.5	42.2	38.7	22	11	11	10.4	9	6.7
6	44.5	40.8	---	---	---	---	---	---
7	49.5	45.4	---	---	---	---	---	---
7.5	54.4	50	28	14.8	14	13.7	12	9
9	---	---	---	18.1	17	16.9	13.9	10.5
11	---	---	42	21	21	20.1	18.4	12.1
15	---	---	54	28.5	28	26.5	23	16.5
18.5	---	---	68	35	35	32.8	28.5	20.2
22	---	---	80	42	40	39	33	24.2
30	---	---	104	57	55	51.5	45	33
37	---	---	130	69	66	64	55	40
45	---	---	154	81	80	76	65	46.8
55	---	---	192	100	100	90	80	58
75	---	---	248	131	135	125	105	75.7
90	---	---	312	162	165	146	129	94
110	---	---	360	195	200	178	156	113
132	---	---	---	233	240	215	187	135
---	---	---	480	222	260	236	207	---
160	---	---	---	285	280	256	220	165
---	---	---	600	---	---	---	---	---
200	---	---	---	352	340	321	281	203
220	---	---	720	388	385	353	310	224
250	---	---	840	437	425	401	360	253
280	---	---	---	---	---	---	---	---
315	---	---	---	555	535	505	445	321
---	---	---	1080	---	---	---	---	---
355	---	---	---	605	580	549	500	350
---	---	---	1200	---	---	---	---	---
400	---	---	---	675	650	611	540	390
450	---	---	1440	---	---	---	---	---
500	---	---	---	855	820	780	680	494
560	---	---	---	950	920	870	760	549
630	---	---	---	1045	1020	965	850	605
710	---	---	---	1200	1140	1075	960	694
800	---	---	---	---	1320	1250	1100	790
900	---	---	---	---	1470	1390	1220	880

ELECTRICAL FORMULAS

Amperes, Horsepower, Kilowatts and KVA

To find	Single Phase	Three Phase	Direct Current
Kilowatts (KW)	$\frac{1 \times E \times PF}{1000}$	$\frac{1 \times E \times 1.73 \times PF}{1000}$	$\frac{1 \times E}{1000}$
KVA	$\frac{1 \times E}{1000}$	$\frac{1 \times E \times 1.73}{1000}$	--
Horsepower (HP) (output)	$\frac{1 \times E \times \% \text{ Eff} \times PF}{1000}$	$\frac{1 \times E \times 1.73 \times \% \text{ Eff} \times PF}{1000}$	$\frac{1 \times E \times \% \text{ Eff}}{746}$
Amperes when Horsepower is known	$\frac{H.P. \times 746}{E \times \% \text{ Eff} \times PF}$	$\frac{H.P. \times 746}{1.73 \times E \times \% \text{ Eff} \times PF}$	$\frac{H.P. \times 746}{E \times \% \text{ Eff}}$
Amperes when Kilowatts is known	$\frac{KW \times 1000}{E \times PF}$	$\frac{KW \times 1000}{1.73 \times E \times PF}$	$\frac{KW \times 1000}{E}$
Amperes when KVA is known	$\frac{KVA \times 1000}{E}$	$\frac{KVA \times 1000}{1.73 \times E}$	--

E = Volts I = Amperes
% Eff = Per cent efficiency PF = Power Factor

Average efficiency and power factor values of motors

When the actual efficiencies and power factors of the motors to be controlled are not known, the following approximations may be used.

Efficiencies:

DC motors, 35 horsepower and less 80% to 85%
DC motors above 35 horsepower 85% to 90%
Synchronous motors (at 100% power factor) 91% to 95%

“Apparent” efficiencies (=Efficiency x Power factor):

Three phase induction motors, 25 horsepower and less than 70%
Three phase induction motors above 25 horsepower 80%
These figures may be decreased slightly for single phase induction motors.

Ratings for three-phase, single-speed, full-voltage, magnetic controllers for non-plugging and non-jogging duty

Size of Contoller	Continuous current rating	Horsepower* at				Service-limit current rating Amperes
		60Hz		50Hz	60Hz	
		200 Volts	230 Volts	380 Volts	460 or 575 Volts	
00	9	1 1/2	1	1	2	11
0	18	3	3	5	5	21
1	27	7 1/2	7 1/2	10	10	32
2	45	10	15	25	25	52
3	90	25	30	50	50	104
4	135	40	50	75	100	156
5	270	75	100	150	200	311
6	540	150	200	300	400	621
7	810	--	300	--	600	932
8	1215	--	450	--	900	1400
9	2250	--	800	--	1600	2590

* These horsepower ratings are based on typical locked-rotor current ratings. For motors having higher locked-rotor currents, a larger controller should be used so that its locked-rotor current rating is not exceeded.